



**NAPCO**

**OPERATING AND INSTALLATION INSTRUCTIONS**

**MAGNUM ALERT 2600-SERIES  
CONTROL PANEL/COMMUNICATOR**

**TABLE OF CONTENTS**

<u>Section</u>	<u>Page</u>	<u>Section</u>	<u>Page</u>
1. INTRODUCTION.....	2	GENERAL PROGRAMMING STEPS.....	14
GENERAL DESCRIPTION.....	2	PROM PROGRAMMING RECORD SHEETS....	16
FEATURES.....	3	KEYPAD PROGRAMMING RECORD SHEETS..	19
SPECIFICATIONS.....	4		
ORDERING INFORMATION.....	5	4. GLOSSARY & PROGRAMMING INFO.....	25
COMPATIBLE UL-LISTED DEVICES.....	5		
2. INSTALLATION.....	6	5. GETTING UP AND RUNNING.....	52
MOUNTING.....	6	PRELIMINARY INFORMATION.....	52
WIRING.....	7	POWER UP & INITIAL CHECKOUT.....	53
ADDING EXPANSION ZONES.....	8	USER KEYPAD PROGRAMMING.....	53
TYPICAL FIRE INSTALLATION.....	9	ARMING & DISARMING THE SYSTEM.....	56
UL MERCANTILE INSTALLATION.....	11	BYPASSING ZONES.....	58
TESTING THE SYSTEM.....	11	ALARM INDICATION.....	58
		THE DISPLAY BUTTON.....	58
3. PROGRAMMING.....	12	SPECIAL FUNCTIONS.....	59
PROM PROGRAMMING.....	12	KEYPAD MESSAGES.....	61
KEYPAD PROGRAMMING USING RP2600 ..	13	6. WIRING LEGEND.....	66
DOWNLOADING FROM A COMPUTER.....	14	WIRING DIAGRAM.....	67

*RP2600 KEYPAD INSTRUCTIONS INCLUDED*

*INDEX STARTS ON PAGE 63*

(See page 62 for a summary of changes from previous edition)

**UL LISTED**

**MA2600LK, MA2600LKDL: Household Fire & Burglary Warning System Control Unit**  
**MA2600LKDLM: Mercantile Burglar Alarm System Control Unit**

## 1. INTRODUCTION

### GENERAL DESCRIPTION

The Magnum Alert 2600 series are state-of-the-art microcomputer-based residential and commercial alarm control panels. Integrally a 16-zone panel (plus Fire and Panic Zones), it will support up to 64 zones (plus Fire and Panic) with the use of optional EZM-series zone expansion modules. The system, with built-in siren driver and communicator, is contained within a wall-mounted enclosure. A transformer is included.

The optional RP2600 keypad features an LCD (liquid-crystal display) readout for English-language messages. In normal daily use, the LCD is used for zone identification and status messages. Conventional LEDs (light-emitting diodes) and a sounder are also provided for annunciation.

The control panel may be fully programmed in its secondary mode of operation by the keypad. In the programming modes (there are two: Dealer and User), the LCD shows memory address, data entry, programming prompts, and the alphanumeric characters required for entering up to 16 user codes and custom zone descriptions.

The panel may also be programmed from a PROM (programmable read-only memory), which is itself programmed on an accessory programmer. Or, data may be quickly and easily downloaded directly using a PC-compatible computer with NAPCO's PCD2000 Quickloader software and PCI2000 computer interface.

**Magnum Alert 2600LKDL.** Designed for use with NAPCO's PCD2000 Quickloader Software Package and PCI2000 Interface, this version includes a factory-installed modem to permit remote downloading/uploading over telephone lines.

**Magnum Alert 2600LKDLM.** The "Mercantile" version is supplied with a heavy-duty enclosure for increased tamper resistance and a tamper switch for tamper protection. (Note that Fire Zones may not be used in Mercantile installations.)

## FEATURES

### Control Panel Features

- Supports up to 64 zones (plus Fire and Panic) with optional zone-expansion modules.
- User-customized English-language zone descriptions, reprogrammable as required.
- English-language prompts and system status messages simplify operation.
- 16 end-of-line-resistor burglary zones programmable for Exit/Entry Delay, Interior, Follower, Day Zone, and Swinger Shutdown.
- Reports alarm, restore, and trouble by zone.
- Two Supervised Fire Zones.
- Two programmable entry delay times.
- Dynamic battery test removes battery from the circuit for test under load.
- Integral dual-tone siren driver.
- Siren driver selectable for sweep, steady, or pulse by zone.
- Exclusive V.A.L.I.D. (TM) feature (Verifying Automatic Line-Integrity Diagnostic) reduces false alarms due to changes in loop resistance.
- Chime by zone, programmable duration.
- Non-volatile RAM retains memory during power losses.

### Communicator Features

- Compatible with all major receiver formats, including BFSK and 4/2.
- Rotary dial and TouchTone(TM) with Rotary backup.
- Three 20-digit telephone numbers.
- Backup Reporting; Double Reporting; Split Reporting.
- 16 User Codes with Opening/Closing Reporting by user.
- Ac Failure Reporting with programmable report delay.
- Communicator Confidence test.

### RP2600 Keypad Features

- English-language LCD display.
- LED and sounder annunciators.
- Accepts up to seven 4-wire keypads.
- Provisions for police and fire emergencies and panic alarms.
- Locate and Fault-Find Modes facilitate testing and troubleshooting.

## MA2600-SERIES SPECIFICATIONS

Operating Temperature:	0-49 degrees C (32-120 degrees F)
Input Power:	16.5Vac via Class 2 Plug-In Transformer TRF12 (19.2VA) or TRF11* (40VA)
Loop Voltage:	10 to 13Vdc
Loop Current:	2.5mA with 2.2k-ohm end-of-line resistor
Wire Resistance:	300 ohms max.
Alarm Outputs:	
Siren/Bell Output:	(Selectable for Speaker or Bell) Siren: 15W, 8 ohms; 30W, 4 ohms min. Sweep; Steady; Pulsing Sweep Bell: 12Vdc, 1.2A max.
Relay Outputs 1 & 2:	SPDT dry contacts, 2A resistive
Auxiliary Output:	12Vdc regulated
Remote Power Output:	12Vdc regulated (for keypads)
Combined Standby Current:	(Remote Power + Auxiliary Output) 350mA with TRF12 Transformer and optional RBAT4 Battery; 650mA with TRF11 and optional RBAT6*.
Keypad Current (typ.)	
RP2600:	40mA
RP2600I:	60mA
Maximum Number of Keypads:	7
Standby Time:	4 Hours min.
Fuses:	
Remote Power:	1A, 1AG (F1)
Auxiliary Power:	3A, 1AG (F3)
Speaker/Bell:	3A, 1AG (F4)
Siren Driver/Alarm Power:	4A, 1AG (F5)
Lithium Battery Life:	5 years (est.)
Enclosure Dimensions	
MA2600LK, MA2600LKDL:	12.6" x 12.6" x 3.6" (HWD) 32cm x 32cm x 9.1cm (HWD)
MA2600LKDLM:	13.1" x 13.0" x 3.8" (HWD) 33.3cm x 33cm x 9.7cm (HWD)
RP2600 Keypad Dimensions:	5.6" x 7.6" x 1.4" (HWD) (Overall) 14.2cm x 19.3cm x 3.4cm (HWD)
Shipping Weight (Approx.):	MA2600LK/LKDL, 9 lb (4.1 kg) MA2600LKDLM, 10-3/4 lb (4.9 kg)

\*The TRF11 (40VA) Transformer and RBAT6 Battery are required for UL Mercantile installations.

## ORDERING INFORMATION

### Equipment Supplied

MA2600LK 12-Volt Alarm Control Panel, Less Keypad; 16-zones (expandable to 64 zones) + Fire & Panic; furnished with integral communicator and siren driver, and TRF11 or TRF12 Power Transformer.

MA2600LKDL As above, but with modem for remote downloading.

MA2600LKDLM As above, but for mercantile installations.

### Optional Accessories and Peripherals

RP2000LCD\* Dual-Mode LCD Keypad, illuminated

RP2000LED\* Remote Arm/Disarm Station, illuminated

RP2600 Dual-Mode LCD Keypad

RP2600I Keypad (as above), illuminated

EZM2004 Zone Expansion Module, 4-Zone

EZM2008 Zone Expansion Module, 8-Zone

EOL2.2K End-of-Line Resistor Assy., 2.2k, for Fire Circuit

FT2200 End of Line Relay/Resistor Supervisory Module

LW5R 5-Zone Relay Board

PS3002 Power-Supply Module

RBAT4 Rechargeable Battery, 12Vdc, 4AH

RBAT6 Rechargeable Battery, 12Vdc, 6AH

RBATH1 Dual Battery Harness

RPB2000 Surface-Mount Backplate for RP2600, RP2600I Keypad

TPS2 Tamper Switches, set of 2

TRF11 Transformer, 16Vac/40VA, Class 2

TRF12 Transformer, 16Vac/19.2VA or 16.5Vac/20VA, Class 2

WL1 Wire Assembly with Lug Connector, 20"

PCD2000 Downloading Software Package for IBM PC-Compatible

PCI2000 Interface for IBM PC-Compatible Computer

PRO410/410M PROM Programmer

PF163 PROM Programming Record Sheets

PF164 Keypad Programming Record Sheets

DD493BNK Blank PROM

OI124 Instruction Manual

A256 Dealer Brochure

A257 Consumer Brochure, Residential

A257COM Consumer Brochure, Commercial

\*See keypad manual for keypad installation and system operation.

### COMPATIBLE UL-LISTED DEVICES (For Residential Installations)

Bells: Ademco AD8-12, AD10-12; Amseco MBL-8/12V, MBL-10/12V

Speakers: Ademco 713; Atlas Sound VT-158U

Smoke Detectors (4-Wire) (6 max): BRK 1812, 2812TH; Pyrotector 3212; 7212. NOTE: (1) 2-wire smoke detectors may not be used. (2) For additional smoke detectors, use a PS3002 Power-Supply Module and connect smokes to PS3002 AUX. POWER Terminals.

NOTE: The MA2600LK/LKDL may not be used for fire where prohibited by local codes. The MA2600LKDLM may not be used for fire in any installation. See Alarm Outputs for Grade-A Bell wiring.

## 2. INSTALLATION

**Note:** This equipment generates and uses radio-frequency energy. If not installed using conventional installation practices for rf devices, it may cause interference to radio and television reception. It has been type tested and found to comply with the limits for a Class B computing device in accordance with the specifications in Subpart J of Part 15 of FCC Rules, which are designed to provide reasonable protection against such interference. However, there is no guarantee that interference will not occur in a particular installation. If it has been found to cause interference to radio or television reception, which can be determined by removing and reapplying ac and battery power to the equipment, the installer is encouraged to try to correct the interference by one or more of the following measures: reorient the receiving antenna; connect the power transformer to a different outlet so that the control panel and receiver are on different branch circuits; relocate the control panel with respect to the receiver.

If necessary, the installer should consult an experienced radio/television technician for additional suggestions or call Napco's Technical Service Department at (800) 645-9445. The booklet "How to Identify and Resolve Radio-TV Interference Problems" prepared by the Federal Communications Commission is available from the U.S. Government Printing Office, Washington DC 20402, Stock No. 004-000-00345-4.

### MOUNTING

**Control Panel.** Choose a mounting location accessible to (a) a continuously-powered ac source, (b) a cold-water-pipe ground ideally no further away than 10 feet, and (c) telephone lines (keep telephone wiring away from speaker wires). Remove appropriate knockouts for cables. Place the control panel at a convenient viewing height and mark the mounting holes.

**Keypad.** A keypad should be located near the exit/entry door. A metal mounting ring is supplied with the RP2600 to accommodate recessed mounting into a wall; an optional backplate (Model RPB-2000 for the RP2600) is available for surface wall mounting (see ORDERING INFORMATION).

**Recessing the RP2600 Keypad into a Wall.** Choose a convenient mounting height. Using a level to maintain horizontal accuracy, mount the supplied metal template onto the wall with the six #6 sheet-metal screws (supplied) through the six elongated holes. (These holes will permit minor levelling adjustments.) Cut away the rectangular portion within the template. For maximum strength, back up the sheet-metal screws from behind the wall with the Tinnerman nuts supplied. Attach the RP2600 to the mounting template with the four #6-32 self-tapping screws, one at each corner.

RP2600 Mounting Ring. Remove shaded area. Elongated holes allow some levelling adjustment. For maximum strength, use Tinnerman nuts behind wall.

NOTE: Cutout approximately 4-1/4" x 6-1/4"

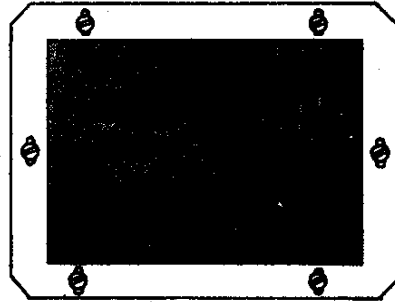

Surface Mounting the RP2600 onto a Wall Using the RPB2000 Backplate. There are two adjacent wire-entry holes in the backplate, one at the bottom and one at the rear. If necessary, use a sharp knife to cut away the rectangular recessed area for additional wire-entry space. Keypad wires may have to be shortened to fit inside the backplate.

Orient the backplate with the word "TOP" at the top. Secure the backplate to the wall using four #6 screws suitable for the surface material. *Important:* Use only the four mounting holes labelled "MTG" -- the other holes are not for mounting purposes and will not work! Raise the RP2600 front panel and secure the keypad to the backplate with the four #6-32 self-tapping screws provided, one at each corner.

NOTE: Do not overtighten the screws! Uneven walls may cause the keypad to become distorted. Should the hinged cover tend to bind when raised or lowered, back the mounting screws out slightly until smooth operation is restored.

Grounding. Connect the control-panel grounding screw to a metal cold-water pipe. Do not use a gas pipe, plastic pipe or ac ground connections. Use at least 16-gauge wire. Make the run as short and direct as possible, without any sharp bends in the wire.

Tamper Switches. Tamper switches may be installed to prevent opening of the control-panel door or removal of the cabinet from the wall. Ideally, tamper switches should be connected to a zone that is active at all times, thus it may be necessary to program that zone for 24-Hour Protection. When used on a normally-open zone, normally-closed tamper switches (open when set) should be wired in parallel. On a normally-closed zone, install NAPCO TPS-2 normally-open tamper switches (closed when set) in series.

There are two places in the cabinet to mount tamper switches:

(1) To prevent cabinet removal from the wall, there are three mounting holes on the left side of the cabinet, another hole on the back that allows the switch button to contact the wall.

(2) To prevent opening the cabinet door, there are three mounting holes on the right side of the cabinet. When mounted, the switch button should contact the inside of the door. Be sure to alert the user that opening the enclosure door will cause a

tamper alarm. (Also see Activate Zone 14 on EZM Tamper.)

**NOTE:** Each NAPCO tamper switch is furnished with three machine screws for mounting, and a single self-tapping screw. The sole purpose of the self-tapping screw is to tap the holes for the machine screws. It is then removed and may be discarded.

### WIRING

Refer to the Wiring Diagram for terminal connections; it contains valuable information not available elsewhere in this manual. *Caution:* Do not run telephone wiring near speaker wires; do not run keypad wiring with loop wiring.

**RP2600 Keypad Assignment.** Up to 7 keypads may be connected to the panel. If more than one keypad is installed,

- (a) each must be assigned its own unique keypad address number (that is, no two keypads may be numbered alike);
- (b) keypads must be numbered consecutively (that is, missing numbers are not permitted); and
- (c) only Keypad No. 1 can be used for programming.

In multiple keypad configurations, the total number of keypads must be programmed in address 995. The number in address 995 must agree with the total number of keypads in the system, or a [KEYPAD FAIL XX] system trouble will result.

RP2600 address numbers are "programmed" by selection of the Address Jumpers, the four-block jumper strip at the extreme lower-right corner of the board (as viewed from the front). Referring to the following table, program the keypad address by *shorting* the respective pair(s) of terminals with a jumper, as indicated by "[:]" (":" indicates *open*).

RP2600 No.	Address Jumper			
	1	2	3	P*
1	:	[:]	[:]	:
2	[:]	:	[:]	:
3	:	:	[:]	[:]
4	[:]	[:]	:	:
5	:	[:]	:	[:]
6	[:]	:	:	[:]
7	:	:	:	[:]

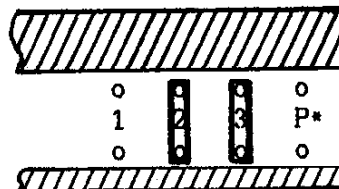

Address Jumpers  
(RP2600 #1 shown)

\*Parking position for unused jumper (located nearest the corner).  
: = Jumper pins open; [:] - Jumper pins shorted.

### ADDING EXPANSION ZONES.

MA2600-Series control panels will handle up to 16 zones, however this number may be increased to up to 64 individually bypassable zones using optional expansion zone modules (EZMs). Two models



are available: the EZM2004 provides 4 additional zones; the EZM-2008, 8 additional zones. Refer to the instructions furnished with the EZM modules (WI429) for expansion-zone wiring and system connection to panel. (Also see Wiring Diagram at end.)

**Power Transformer Selection.** The zone-expansion modules are powered by the control panel, and therefore affect the current available at the panel's Auxiliary Power Output terminals (Terminals 12 and 13), just as additional keypads do. The following tables show available Auxiliary Power Output current for 16 to 64 zones, with the number of RP2600 keypads and power sources as parameters, if the "Suggested-EZMs" configuration is chosen.

No. of Zones	Suggested EZMs		Current Available (mA) for No. of RP2600s						
	2004s	2008s	1	2	3	4	5	6	7
16	-	-	350	310	270	230	190	150	110
20	1	-	310	270	230	190	150	110	70
24	-	1	300	260	220	180	140	100	60
28	1	1	260	220	180	140	100	60	20
32	-	2	250	210	170	130	90	50	10
36	1	2	210	170	130	90	50	10	NA
40	-	3	200	160	120	80	40	0	NA
44	1	3	160	120	80	40	0	NA	NA
48	-	4	150	110	70	30	NA	NA	NA
52	1	4	110	70	30	NA	NA	NA	NA
56	-	5	100	60	20	NA	NA	NA	NA
60	1	5	60	20	NA	NA	NA	NA	NA
64	-	6	50	10	NA	NA	NA	NA	NA

Available Auxiliary Power-Output current. Standby Time = 4 hours; Transformer = TRF12 (19.2VA); Battery = RBAT4 (4AH). NA = system configuration not allowed due to current restrictions.

No. of Zones	Suggested EZMs		Current Available (mA) for No. of RP2600s						
	2004s	2008s	1	2	3	4	5	6	7
16	-	-	650	610	570	530	480	440	400
20	1	-	610	570	530	490	450	410	370
24	-	1	600	560	520	480	440	400	360
28	1	1	560	520	480	440	400	360	320
32	-	2	550	510	470	430	390	350	310
36	1	2	510	470	430	390	350	310	270
40	-	3	500	460	420	380	340	300	260
44	1	3	460	420	380	340	300	260	220
48	-	4	450	410	370	330	290	250	210
52	1	4	410	360	320	280	240	200	160
56	-	5	400	350	310	270	230	190	150
60	1	5	360	320	280	240	200	160	120
64	-	6	350	310	270	230	190	150	110

Available Auxiliary Power-Output current. Standby Time = 4 hours; Transformer = TRF11 (40VA); Battery = RBAT6 (6AH).

**TYPICAL FIRE INSTALLATION** (Where permitted by local codes, not for Mercantile installations.)

At least one smoke detector should be installed directly outside each sleeping area. If there is more than one floor, additional smoke detectors should be installed on each level, including the basement. The living-area and basement smoke detectors should be installed near the stairway of the next upper level.

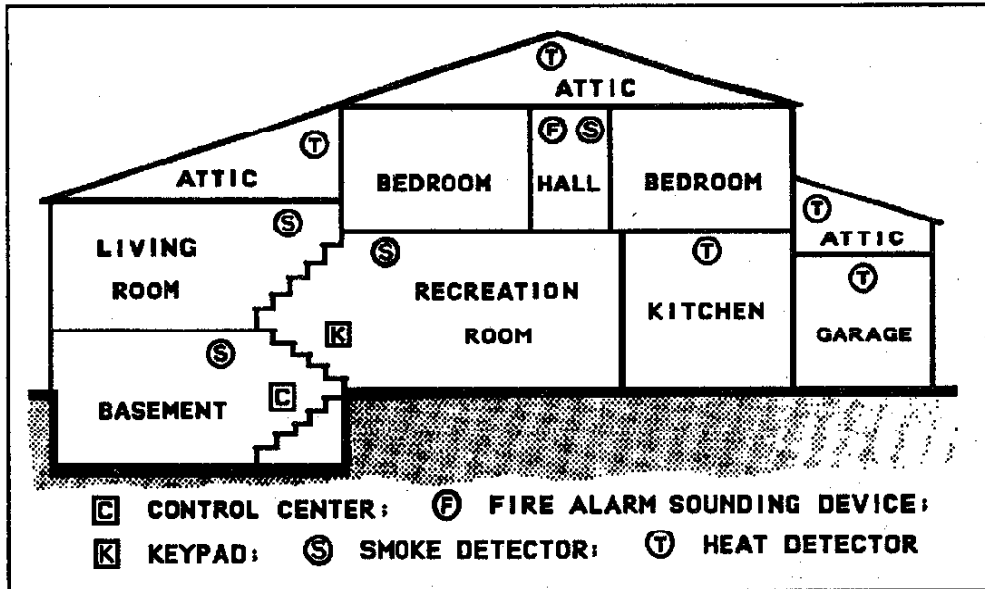

For increased protection, additional detectors should be installed in areas other than those required, such as the dining room, bedrooms, utility room, furnace room, and hallways. Heat detectors, rather than smoke detectors, are recommended in kitchens, attics, and garages due to conditions that may result in false alarms and improper operation. Large areas and areas with partitions, ceiling beams, doorways, and open joists will require additional detectors.

Refer to NFPA Standard No. 74 (National Fire Protection Association, Batterymarch Park, Quincy, MA 02269) for additional information, including proper mounting of detectors.

## UL MERCANTILE INSTALLATIONS

The MA2600LKDLM can be used as part of a UL Central Station Grade C, B, or A installation. Normally, a digital communicator is classified as Grade C and may be classified Grade B if used with the specified Grade-A Local bell and bell housing. A UL Central Station Grade-A installation requires the use of a Napco LW5R Relay Board, Ademco 7600 Radio System and Ademco 659EN Line Fault Monitor. Refer to the installation instructions furnished with each component for respective installation requirements.

For a UL Grade-A Police Station Connection, refer to **GRADE-A LOCAL MERCANTILE INSTALLATIONS**, which follows, and use the integral digital alarm communicator or the LW5R as part of a long-range wireless system to provide basic line security. Refer to the installation instructions accompanying each component for other installation requirements.

### GRADE-A LOCAL MERCANTILE INSTALLATIONS

A Grade-A Local Mercantile installation must use a Napco TRF11 Transformer and a 6.OAH standby battery. The digital communicator must be employed and a Forced Arm Code must be programmed. Programming must include Auto Bell Test Upon Arming. Trouble On Night Open may not be programmed. Fire Zones may not be used.

The minimum requirements for a listed Grade-A Local system include:

- Low-Battery Annunciation unless a dialer is used to transmit a low-battery message.
- A heavy-duty enclosure with door tamper protection
- An Ademco AB-12 Bell and Box (12-volt; see Alarm Outputs for wiring)
- Program *Auto Bell Test Upon Arming*
- a maximum Exit Delay of 60 seconds

### TESTING THE SYSTEM

After installation is completed, test the system as follows. Call the central station to inform them of the test. Initiate an alarm (preferably on a zone that activates a steady siren) and verify proper signalling. Then, call the central station to confirm their receipt of a good transmission.

### 3. PROGRAMMING

The control panel is programmed by any of the following methods, each of which is described in detail in the following paragraphs.

- (a) PROM programming using a PRO410;
- (b) Keypad programming;
- (c) Local or remote downloading using an IBM PC-compatible computer with NAPCO PCD2000 Quickloader software and PCI2000 interface.

#### PROM PROGRAMMING

A DD493BNK blank PROM may be programmed using a PRO410/410M Programmer. Refer to the manual furnished with the programmer for operating instructions. All features may be programmed except

- Arm/Disarm Codes
- Exit/Entry Times
- Subscriber Identification Numbers
- Number of Keypads
- Test-Timer Offset
- Test-Timer Interval
- Zone Descriptions

Transferring Memory from a PROM. The data programmed in the PROM are saved in memory as follows (refer to the Wiring Diagram).

1. At the control panel, with ac and battery power off, insert the programmed PROM into the MEMORY CHIP socket. Align the dot on the PROM with the dot on the circuit board.
2. Apply power (see INSTALLATION: POWER-UP SEQUENCE).
3. Raise the RP2600 cover and enter the Dealer Program Code.
4. Access address 999 (Load PROM) then press the SAVE Button ([ON/OFF]) to load all data (including blanks). See Dealer Keypad Programming.
5. Close the keypad cover.
6. Remove power, then remove the PROM from the socket.
7. With keypad cover closed, power up normally.

NOTE: Do not leave the PROM installed. A PROM left in the PROM socket will result in a system-trouble condition.

PROM Programming Sheets. PROM Programming Sheets (PF163) similar to those which follow are completed when planning system features and communicator information for the particular installation. These sheets should be retained for future reference. Refer to the glossary for programming information and instructions.

#### KEYPAD PROGRAMMING USING THE RP2600

NOTE: Only the main keypad (designated RP2600 #1) may be used for

programming (see RP2600 Keypad Assignment in Section 2).

Keypad Programming may be divided into two subgroups: User (Program 1) Mode and Dealer (Program 2) Mode. USER KEYPAD PROGRAMMING (covered in Section 5) is limited to user codes, exit/entry times and zone descriptions. In the Dealer Program Mode, the keypad is capable of all programming *except zone descriptions*.

**Dealer Keypad Programming.** Set the keypad to the Dealer Program Mode: raise the RP2600 keypad cover, enter the Dealer Security Code, then press the [ON/OFF] Button. The display will briefly read [PROGRAM2 #XXXX], then indicate [ADDR=Q00 DATA=..]. (Dots in the data display represent *blanks*.) Subpanel markings (shown in parentheses) indicate the buttons' secondary functions.

**NOTE:** The Dealer Program Mode may be accessed while the panel is armed if the Dealer Security Code is entered within 5 minutes of (a) power-up or (b) control-panel reset, unless the panel is first disarmed and then rearmed.

In this mode of operation, the numeric keys no longer perform as expected: Keys [1] and [2] position the cursor left and right respectively within the display; Keys [4] and [7] scroll up and down respectively through ADDR numbers 0-9; and DATA numbers 1-9, 0, letters B, C, D, E, F, and . (dot, which represents a *blank*) at the selected cursor position. The following buttons also take on new meanings in the Program 2 Mode:

- [NO DELAY] (NEXT) scrolls the display line forward to the next address and reads the data in that address (hold down NEXT for fast forward).
- [INTERIOR OFF] (PRIOR) scrolls the display line backward to the previous address and reads the data in that address (hold down PRIOR for fast reverse).
- Key [0] (READ) reads the data in the address manually selected (when the address is manually entered, the data in that address are not read until the READ Button is pressed).
- Key [5] (BLANK) clears the display at the cursor position.
- [ON/OFF] (SAVE) stores the programmed data in memory.

**NOTE:** Exit the Dealer Program Mode before removing power to the control panel. Failure to do so will result in loss of all programmed information.

**Keypad Programming Sheets.** Keypad Programming Sheets (PF164) similar to those which follow are completed when planning system features and communicator information for the particular installation. Many of the addresses shown comprise two data "bits", a left and a right. Program the left bit on the left data-display segment, and the right bit on the right segment. For those addresses having only one programmable bit, program the right segment *only*; the left segment should display a dot (blank).

Refer to the glossary for programming information and instructions. Save these sheets for future reference.

## LOCAL/REMOTE DOWNLOADING FROM A PC-COMPATIBLE COMPUTER WITH NAPCO QUICKLOADER SOFTWARE AND INTERFACE.

Data may be downloaded directly into the control panel either locally or remotely via telephone lines using any IBM PC-compatible computer with NAPCO PCD2000 software and PCI2000 computer interface. An installer need not be on the premises to remotely transfer data; using the *Callback Method*, data will be transferred automatically after 15 rings (unless programmed otherwise) and a panel confirmation callback. Or, if an installer is at the site, a *Function-8 Method* data transfer may be executed manually. See Function 8: **MANUAL DOWNLOAD**. Instructions for installing and running the PCD2000 program is provided in the software package. On-screen prompting and the extensive use of help menus simplify programming, and an error-checking mode locates omissions and incompatible data to reduce the possibility of mistakes.

**NOTE:** Remote downloading requires the MA2600LKDL option and a compatible PC modem.

**Downloading Messages.** The PCD2000 Quickloader Software and PCI-2000 Interface also provide for downloading brief messages (such as shutdown warnings of discontinuance of service) and also, within limits, to remotely disable the panel. Four degrees of intervention are possible:

- Level 1: Message permanently cleared by pressing the [RESET] Button. No intervention of panel operation.
- Level 2: Message temporarily cleared by pressing the [RESET] Button. Message returns after 5 minutes or after arming and disarming the panel.
- Level 3: Message temporarily cleared by pressing the [RESET] Button. Message returns after 5 minutes. Arming and disarming are disabled.
- Level 4: Message temporarily cleared by pressing the [RESET] Button. Message returns after 5 minutes. Communicator is disabled.

**NOTE:** Levels 3 and 4 may be combined to disable both arming/disarming and the communicator.

The message will display as a line of stars, followed by four lines of text that scroll continuously. The message may be permanently cleared using the PCI2000, or from the keypad as follows: (a) Enter the Dealer Program Mode; (b) access Location 990 (Clear Shutdown Message); (c) press the GAVE [ON/OFF] Button.

## GENERAL PROGRAMMING STEPS

1. Contact the central station to confirm receiver format, data format, event codes, subscriber numbers and telephone number(s). Two receiver descriptions and telephone numbers, and

up to 4 Subscriber Identification Numbers may be required.

2. Complete the Programming Sheet. Reference record sheets for the MA2600LK are furnished in the following pages. Select the desired features by circling the respective "address" boxes. Refer to the GLOSSARY for guidance in selecting "data" entries (1,2,4,8).
3. To program the subscriber PROM, follow the instructions furnished with the programmer. While programming, remember to keep the address *page number* in mind, and be sure that the position of the PAGE switch (PRO410/410M) is set accordingly.

NOTE: If using the PRO410/410M, before attempting to program either page, be sure that all data in programmer memory are erased (press [ERASE], then [EXECUTE]).

4. Program the data entries in the boxes on the Programming Record Sheets into the respective locations or addresses. The display will show the entry numerically, but will display "0" for the number "10", and letters "B" or "b", "C", "D" or "d", "E", and "F" for the numbers "11" through "15", respectively. To program a "10", enter [0]. To program "11" through "15", enter [B] through [F] respectively. If using the PRO410/410M, use the [PLUS] key to enter any two or more digits that add up to the desired entry.

Entry Total:	10	11	12	13	14	15
Display:	0	B	C	D	E	F

(PRO410/410M only): To program "13", for example, enter either [d] or [8] [PLUS] [5], or [8] [PLUS] [4] [PLUS] [1], etc.

Similarly, to add to an existing PROM location, *first* press the [PLUS] key, *then* the complementary digit, otherwise the digit entered will *replace* the digit in memory. Refer to the PRO410/410M instruction booklet for further programming information.

The default program is in memory when shipped from the factory, and is used on power-up. (See Keypad Programming Sheet (PF164) or Load Default Program.)

# MA2600 PROM PROGRAMMING SHEET

## TRANSMISSION INFORMATION

(ALL LOCATIONS ON THIS PAGE REFER TO PROM PAGE ZERO)

CUSTOMER: \_\_\_\_\_  
 ADDRESS: \_\_\_\_\_  
 ACCOUNT NO. \_\_\_\_\_  
 TEL: \_\_\_\_\_  
 DATE: \_\_\_\_\_

TEL NO.	FORMAT		TELEPHONE NUMBER (DIAL-TONE DETECTION "E" OR PRE-DIAL DELAY "D" REQUIRED AS FIRST ENTRY)																			
	RCVR	DATA	000	001	002	003	004	005	006	007	008	009	010	011	012	013	014	015	016	017	018	019
1	080	083 082																				
2	084	087 086	020	021	022	023	024	025	026	027	028	029	030	031	032	033	034	035	036	037	038	039
3	088	091 090	040	041	042	043	044	045	046	047	048	049	050	051	052	053	054	055	056	057	058	059

ENTRY		RECEIVER FORMAT		DATA FORMAT	
BLANK	1	ADEMCO SLOW, SILENT KNIGHT SLOW	1	ENTRY	1
1	2	SESCOA, VERTEX, DCI, FRANKLIN	2	2	2300Hz HANDSHAKE
2	3	RADIONICS FAST	3	4	2300Hz KISSOFF
3	4	SILENT KNIGHT FAST	4	8	2-DIGIT OR 4/2
4	5	RADIONICS, DCI, FRANKLIN SLOW	5	8	SINGLE DIGIT ONLY
5	8	UNIVERSAL HI-SPEED	8		
8		RADIONICS BFSK			

DOWNLOAD TELEPHONE NUMBER

060	061	062	063	064	065	066	067	068	069	070	071	072	073	074	075	076	077	078	079
-----	-----	-----	-----	-----	-----	-----	-----	-----	-----	-----	-----	-----	-----	-----	-----	-----	-----	-----	-----

BANK ZERO ALARM CODES								BANK ONE ALARM CODES								BANK TWO ALARM CODES							
FIRE USED	NOT USED	FIRE TBL	AMB	PAN	LOW	AC	BATT FAIL	1	2	3	4	5	6	7	8	9	10	11	12	13	14	15	16
092	094	096	098	100	102	104		109	111	113	115	117	119	121	123	125	127	129	131	133	135	137	139
093	095	097	099	101	103	105		110	112	114	116	118	120	122	124	126	128	130	132	134	136	138	140

EVENT CODES (NOT USED IN BFSK FORMAT)

EVENT	BANK 0	BANK 1	BANK 2	BANK 3	BANK 4	BANK 5	BANK 6	BANK 7	BANK 8	
ALARM----->	(USE THE ABOVE ALARM CODES)	150	153	156	159	162	165			
RESTORE----->		142	145	148	151	154	157	160	163	166
TROUBLE/STATUS-->		146	149	152	155	158	161	164	167	

**ALARMS, BANKS 0, 1, 2**  
 PULSE- uses above alarm codes (1st and/or 2nd code)  
 BFSK - "ALARM" then 2nd code (1st if 2nd blank)

**ALARMS, BANKS 3 THROUGH 8**  
 PULSE- alarm type then position of zone (1-8)  
 BFSK - "ALARM" then position of zone (1-8)

**TROUBLES, BANKS 1, 2**  
 PULSE- alarm type then 2nd code (1st if 2nd blank)  
 BFSK - "TROUBLE" then 2nd code (1st if 2nd blank)

**TROUBLES, BANKS 3 THROUGH 8**  
 PULSE- alarm type then position of zone (1-8)  
 BFSK - "TROUBLE" then position of zone (1-8)

**RESTORES, BANKS 0, 1, 2**  
 PULSE- alarm type then 2nd code (1st if 2nd blank)  
 BFSK - "RESTORE" then 2nd code (1st if 2nd blank)

**RESTORES, BANKS 3 THROUGH 8**  
 PULSE- restore alarm type then position of zone (1-8)  
 BFSK - "RESTORE" then position of zone (1-8)

**TROUBLE RESTORES, BANKS 1, 2**  
 PULSE- restore alarm type then trouble alarm type  
 BFSK - "RESTORE" then 2nd code (1st if 2nd blank)

**TROUBLE RESTORES, BANKS 3 THROUGH 8**  
 PULSE- restore alarm type then trouble alarm type  
 BFSK - "RESTORE" then position of zone (1-8)

106	107	108	*LEAVE BLANK IF NOT REPORTING FORCE ARM; NOT USED FOR STATUS, BFSK, 4/2.
OPENING CODE	CLOSING CODE	*FORCE ARM CODE	



# MA2600 PROM PROGRAMMING SHEET

## ZONE FEATURES

FEATURE	FROM PAGE ONE												FROM PAGE ZERO																
	BANK TWO						BANK ONE						BANK ZERO																
	ZONE			ZONE			ZONE			ZONE			LOC	AC	LB	PA	LOC	AM	FT	F2	F1								
	LOC	16	15	14	13	LOC	12	11	10	9	LOC	8	7	6	5	LOC	4	3	2	1	LOC	AC	LB	PA	LOC	AM	FT	F2	F1
LOOP RESPONSE 50ms	123	8	4	2	1	122	8	4	2	1	027	8	4	2	1	026	8	4	2	1	*	*	*	*	*	*	*	*	*
LOOP RESPONSE 10ms	125	8	4	2	1	124	8	4	2	1	029	8	4	2	1	028	8	4	2	1	*	*	*	*	*	*	*	*	*
PRIORITY ZONE	127	8	4	2	1	126	8	4	2	1	031	8	4	2	1	030	8	4	2	1	195	4	2	1	194	*	4	2	1
PRIORITY W/BYPASS	129	8	4	2	1	128	8	4	2	1	033	8	4	2	1	032	8	4	2	1	197	4	2	1	196	*	4	2	1
AUTO BYPASS	131	8	4	2	1	130	8	4	2	1	035	8	4	2	1	034	8	4	2	1	*	*	*	*	*	*	*	*	*
SELECTIVE BYPASS	133	8	4	2	1	132	8	4	2	1	037	8	4	2	1	036	8	4	2	1	*	*	*	*	*	*	*	*	*
GROUP (INTERIOR) BYPASS	135	8	4	2	1	134	8	4	2	1	039	8	4	2	1	038	8	4	2	1	*	*	*	*	*	*	*	*	*
24-HOUR PROTECTION	137	8	4	2	1	136	8	4	2	1	041	8	4	2	1	040	8	4	2	1	*	*	*	*	*	*	*	*	*
SWEEP SIREN	139	8	4	2	1	138	8	4	2	1	043	8	4	2	1	042	8	4	2	1	199	4	2	1	198	*	4	2	1
PULSE-SWEEP SIREN	141	8	4	2	1	140	8	4	2	1	045	8	4	2	1	044	8	4	2	1	201	4	2	1	200	*	4	2	1
STEADY SIREN	143	8	4	2	1	142	8	4	2	1	047	8	4	2	1	046	8	4	2	1	203	4	2	1	202	*	4	2	1
RELAY OUTPUT 1	145	8	4	2	1	144	8	4	2	1	049	8	4	2	1	048	8	4	2	1	205	4	2	1	204	*	4	2	1
RELAY OUTPUT 2	147	8	4	2	1	146	8	4	2	1	051	8	4	2	1	050	8	4	2	1	207	4	2	1	206	*	4	2	1
EXIT/ENTRY 1	149	8	4	2	1	148	8	4	2	1	053	8	4	2	1	052	8	4	2	1	*	*	*	*	*	*	*	*	*
EXIT/ENTRY 2	151	8	4	2	1	150	8	4	2	1	055	8	4	2	1	054	8	4	2	1	*	*	*	*	*	*	*	*	*
E/E FOLLOWER	153	8	4	2	1	152	8	4	2	1	057	8	4	2	1	056	8	4	2	1	*	*	*	*	*	*	*	*	*
AUTO RESET	155	8	4	2	1	154	8	4	2	1	059	8	4	2	1	058	8	4	2	1	*	*	*	*	*	*	*	*	*
SWINGER SHUTDOWN	157	8	4	2	1	156	8	4	2	1	061	8	4	2	1	060	8	4	2	1	*	*	*	*	*	*	*	*	*
CHIME	159	8	4	2	1	158	8	4	2	1	063	8	4	2	1	062	8	4	2	1	*	*	*	*	*	*	*	*	*
ABORT DELAY	161	8	4	2	1	160	8	4	2	1	065	8	4	2	1	064	8	4	2	1	*	*	*	*	208	*	4	2	1
POWER-UP DELAY	163	8	4	2	1	162	8	4	2	1	067	8	4	2	1	066	8	4	2	1	*	*	*	*	*	*	*	*	*
DAY ZONE OPEN	165	8	4	2	1	164	8	4	2	1	069	8	4	2	1	068	8	4	2	1	*	*	*	*	*	*	*	*	*
DAY ZONE SHORT	167	8	4	2	1	166	8	4	2	1	071	8	4	2	1	070	8	4	2	1	*	*	*	*	*	*	*	*	*
ALARM ON DAY ZONE	169	8	4	2	1	168	8	4	2	1	073	8	4	2	1	072	8	4	2	1	*	*	*	*	*	*	*	*	*
REPORT TELCO 1																													
ALARM	171	8	4	2	1	170	8	4	2	1	075	8	4	2	1	074	8	4	2	1	219	4	2	1	218	8	4	2	1
ALARM RESTORE	173	8	4	2	1	172	8	4	2	1	077	8	4	2	1	076	8	4	2	1	221	4	2	1	220	*	4	2	1
TROUBLE	175	8	4	2	1	174	8	4	2	1	079	8	4	2	1	078	8	4	2	1	*	*	*	*	*	*	*	*	*
TROUBLE RESTORE	177	8	4	2	1	176	8	4	2	1	081	8	4	2	1	080	8	4	2	1	*	*	*	*	*	*	*	*	*
REPORT TELCO 3 (DOUBLE AND SPLIT REPORTING)																													
ALARM	187	8	4	2	1	186	8	4	2	1	091	8	4	2	1	090	8	4	2	1	235	4	2	1	234	8	4	2	1
ALARM RESTORE	189	8	4	2	1	188	8	4	2	1	093	8	4	2	1	092	8	4	2	1	237	4	2	1	236	*	4	2	1
TROUBLE	191	8	4	2	1	190	8	4	2	1	095	8	4	2	1	094	8	4	2	1	*	*	*	*	*	*	*	*	*
TROUBLE RESTORE	193	8	4	2	1	192	8	4	2	1	097	8	4	2	1	096	8	4	2	1	*	*	*	*	*	*	*	*	*
NO EOL RESISTOR	195	8	4	2	1	194	8	4	2	1	099	8	4	2	1	098	8	4	2	1									
PIR SUPERVISION	197	8	4	2	1	196	8	4	2	1	101	8	4	2	1	100	8	4	2	1									
TROUBLE ON OPEN	199	8	4	2	1	198	8	4	2	1	103	8	4	2	1	102	8	4	2	1									
TROUBLE ON SHORT	201	8	4	2	1	200	8	4	2	1	105	8	4	2	1	104	8	4	2	1									
TROUBLE ON NIGHT OPEN	203	8	4	2	1	202	8	4	2	1	107	8	4	2	1	106	8	4	2	1									

NOTE: LEAVE PAGE ZERO,  
LOCATION 244 BLANK.

	FROM PAGE ONE																							
	USERS OPENING/CLOSING																							
	USER				USER				USER				USER											
	LOC	15	14	13	LOC	12	11	10	9	LOC	8	7	6	5	LOC	4	3	2	1	LOC	4	3	2	1
CLOSING REPT TELCO 1	003	*	4	2	1	002	8	4	2	1	001	8	4	2	1	000	8	4	2	1				
OPENING REPT TELCO 1	007	*	4	2	1	006	8	4	2	1	005	8	4	2	1	004	8	4	2	1				
CLOSING REPT TELCO 3	019	*	4	2	1	018	8	4	2	1	017	8	4	2	1	016	8	4	2	1				
OPENING REPT TELCO 3	023	*	4	2	1	022	8	4	2	1	021	8	4	2	1	020	8	4	2	1				

## MA2600 PROM PROGRAMMING SHEET

### PROM PAGE ZERO

	187	186	
RESET TEST TIMER ON ANY REPORT	1	1	BACKUP REPORT TELCO 1, 2
ACTIVATE ZONE 14 ON EZM TAMPER	2	2	TOUCHTONE DIALING ONLY
(RESERVED)	4	4	TOUCHTONE WITH ROTARY BACKUP
(RESERVED)	8	8	REPORT TEST TIMER ON ZONE 16

### PROM PAGE ONE

	237	236	
DISABLE FUNCTION-8 DOWNLOAD	1	1	INTERIOR NORMALLY BYPASSED
DISABLE CALLBACK DOWNLOAD	2	2	(RESERVED)
DISABLE CARRIER DOWNLOAD	4	4	RESET DAY ZONE WITH ARM/DISARM ONLY
DISABLE AUTO-RESET ON DAY ZONE	8	8	WATCH ON WITH FUNCTION 2

	239	238	
ACCESS CONTROL ON RELAY OUTPUT 2	1	1	AUTO BELL TEST UPON ARMING
EASY ARM WITH ON/OFF BUTTON	2	2	AUTO RESET AFTER SWEEP SIREN TIMEOUT
REPORT SERVICE CODE AS USER 15	4	4	POWER UP IN LAST STATE
START EXIT DELAY AFTER RINGBACK	8	8	DISABLE SMOKE RESET ON RELAY 1

	241	240	
ENABLE RED BUTTONS AS FIRE ZONE	1	1	OPENING REPORT ONLY AFTER ALARM REPORT
ENABLE GREEN BUTTONS AS ZONE 15	2	2	CLOSING ONLY ON FORCE ARM (AUTO-BYPASS)
ENABLE BLUE BUTTONS AS PANIC	4	4	INCL SEL/GRP BYPASS IN FORCE ARM/STATUS
ENABLE TELCO TEST ON KEYPAD TEST	8	8	STATUS RPT (AUTO-BYPASS ZONES ON CLOS.)

	x16	x1
TIME-OUTS		
RELAY OUTPUT 1 TIME (MINUTES)	219	218
RELAY OUTPUT 2 TIME (MINUTES)	221	220
RELAY OUTPUT 2 ACCESS CONTROL TIME (SECONDS)	223	222
SWEEP SIREN TIME (MINUTES)	225	224
PULSE-SWEEP SIREN TIME (MINUTES)	227	226
STEADY SIREN TIME (MINUTES)	229	228
ABORT DELAY TIME (SECONDS)	231	230
CHIME TIME (SECONDS)	233	232
AC FAIL REPORT DELAY (MINUTES)	235	234

# MA2600 KEYPAD PROGRAMMING SHEET

CUSTOMER: \_\_\_\_\_  
 ADDRESS: \_\_\_\_\_  
 ACCOUNT NO. \_\_\_\_\_  
 DATE: \_\_\_\_\_  
 TEL: \_\_\_\_\_

EXIT DELAY TIME (SEC)      ENTRY DELAY 1 TIME (SEC)      ENTRY DELAY 2 TIME (SEC)

DEFAULT PROGRAM IN PARENTHESES----> (3) 

000
-----

 (C)      (1) 

001
-----

 (E)      (1) 

002
-----

 (E)

$\begin{array}{|c|c|} \hline \times 16 & \times 1 \\ \hline \end{array}$ 
 $\begin{array}{|c|c|} \hline \times 16 & \times 1 \\ \hline \end{array}$ 
 $\begin{array}{|c|c|} \hline \times 16 & \times 1 \\ \hline \end{array}$

### USER ARM/DISARM CODES

USER 1						USER 2						USER 3						USER 4					
003	004	005	006	007	008	009	010	011	012	013	014	015	016	017	018	019	020	021	022	023	024	025	026
(7)	(8)	(9)																					
USER 5						USER 6						USER 7						USER 8					
027	028	029	030	031	032	033	034	035	036	037	038	039	040	041	042	043	044	045	046	047	048	049	050
USER 9						USER 10						USER 11						USER 12					
051	052	053	054	055	056	057	058	059	060	061	062	063	064	065	066	067	068	069	070	071	072	073	074
USER 13						USER 14						USER 15						USER 16					
075	076	077	078	079	080	081	082	083	084	085	086	087	088	089	090	091	092	093	094	095	096	097	098

SERVICE CODE						USER PROGRAM CODE						ACCESS CODE						AMBUSH CODE	
099	100	101	102	103	104	105	106	107	108	109	110	111	112	113	114	115	116	117	118

(1) (2) (3) (4) (5) (6)

### TRANSMISSION INFORMATION

DEALER SECURITY CODE\*

CALLBACK TELEPHONE NUMBER

119	120	121	122	123	124	188	189	190	191	192	193	194	195	196	197	198	199	200	201	202	203	204	205	206	207

TEL NO.      FORMAT RCVR      DATA

1	208	209
2	210	211
3	212	213

DIALER TELEPHONE NUMBER

(DIAL-TONE DETECTION "E" OR PRE-DIAL DELAY "D" REQUIRED AS FIRST ENTRY)

128	129	130	131	132	133	134	135	136	137	138	139	140	141	142	143	144	145	146	147	
(E)																				
148	149	150	151	152	153	154	155	156	157	158	159	160	161	162	163	164	165	166	167	
(E)																				
168	169	170	171	172	173	174	175	176	177	178	179	180	181	182	183	184	185	186	187	
(E)																				

ENTRY	RECEIVER FORMAT
BLANK	ADEMCO SLOW, SILENT KNIGHT SLOW
1	SESCOA, VERTEX, DCI, FRANKLIN FAST
2	RADIONICS FAST
3	SILENT KNIGHT FAST
4	RADIONICS, DCI, FRANKLIN SLOW
5	UNIVERSAL HI-SPEED
8	RADIONICS BFSK

DATA FORMAT	
ENTRY	ENTRY
1	SUM CHECK
2	(NOT USED)
4	(NOT USED)
8	(NOT USED)
1	2300Hz HANDSHAKE
2	2300Hz KISSOFF
4	2-DIGIT OR 4/2
8	SINGLE DIGIT ONLY

\*SEE LABEL ON MICRO CAN FOR MASTER SECURITY CODE. ALSO SEE "DEALER SECURITY CODE" IN GLOSSARY

## MA2600 KEYPAD PROGRAMMING SHEET

SUBSCRIBER I.D. NUMBERS, TELEPHONE #1	248	249	250	251	252	253	254	255	256	257	258	259	260	261	262	263	264	265	266	267
	OPEN/CLOSE				BANK ZERO				BANK ONE				BANK TWO				BANK THREE			
	268	269	270	271	272	273	274	275	276	277	278	279	280	281	282	283	284	285	286	287
	BANK FOUR				BANK FIVE				BANK SIX				BANK SEVEN				BANK EIGHT			
-----																				
SUBSCRIBER I.D. NUMBERS, TELEPHONE #2	288	289	290	291	292	293	294	295	296	297	298	299	300	301	302	303	304	305	306	307
	OPEN/CLOSE				BANK ZERO				BANK ONE				BANK TWO				BANK THREE			
	308	309	310	311	312	313	314	315	316	317	318	319	320	321	322	323	324	325	326	327
	BANK FOUR				BANK FIVE				BANK SIX				BANK SEVEN				BANK EIGHT			
-----																				
SUBSCRIBER I.D. NUMBERS, TELEPHONE #3	328	329	330	331	332	333	334	335	336	337	338	339	340	341	342	343	344	345	346	347
	OPEN/CLOSE				BANK ZERO				BANK ONE				BANK TWO				BANK THREE			
	348	349	350	351	352	353	354	355	356	357	358	359	360	361	362	363	364	365	366	367
	BANK FOUR				BANK FIVE				BANK SIX				BANK SEVEN				BANK EIGHT			

BANK ZERO ALARM CODES										BANK ONE ALARM CODES								BANK TWO ALARM CODES							
FIRE #1	FIRE #2	FIRE TBL	AMB	PAN	LOW BATT	AC FAIL	1	2	3	4	5	6	7	8	9	10	11	12	13	14	15	16			
368	370	372	374	376	378	380	385	387	389	391	393	395	397	399	401	403	405	407	409	411	413	415			
(1)	(1)	(1)	(2)	(2)	(1)	(1)	(3)	(3)	(3)	(3)	(3)	(3)	(3)	(3)	(4)	(4)	(4)	(4)	(4)	(4)	(4)	(4)			
369	371	373	375	377	379	381	386	388	390	392	394	396	398	400	402	404	406	408	410	412	414	416			
(1)	(2)	(1)	(1)	(2)	(8)	(9)	(1)	(2)	(3)	(4)	(5)	(6)	(7)	(8)	(1)	(2)	(3)	(4)	(5)	(6)	(7)	(8)			

EVENT CODES (NOT USED IN BFSK FORMAT)										
EVENT	BANK 0	BANK 1	BANK 2	BANK 3	BANK 4	BANK 5	BANK 6	BANK 7	BANK 8	PULSE- BFSK -
ALARM----->	(USE ABOVE ALARM CODES)			426	429	432	435	438	441	uses above alarm codes (1st and/or 2nd code) "ALARM" then 2nd code (1st if 2nd blank)
				(5)	(6)	(7)	(8)	(9)	(0)	Event Code then position of zone (1-8) "ALARM" then position of zone (1-8)
RESTORE----->	418	421	424	427	430	433	436	439	442	Event Code then 2nd code (1st if 2nd blank) "TROUBLE" then 2nd code (1st if 2nd blank)
	(E)	(E)	(E)	(E)	(E)	(E)	(E)	(E)	(E)	Event Code then position of zone (1-8) "TROUBLE" then position of zone (1-8)
TROUBLE/STATUS->	422	425	428	431	434	437	440	443		Event Code then 2nd code (1st if 2nd blank) "RESTORE" then 2nd code (1st if 2nd blank)
	(F)	(F)	(F)	(F)	(F)	(F)	(F)	(F)		Event Code then position of zone (1-8) "RESTORE" then by position of zone (1-8)

382	383	384	
(B)	(C)	(F)	
OPENING CODE	CLOSING CODE	*FORCE ARM CODE	*LEAVE BLANK IF NOT REPORTING FORCE ARM; NOT USED FOR STATUS, BFSK, 4/2.

	<p style="text-align: center;"><u>ALARMS, BANKS 0, 1, 2</u></p> <p>PULSE- uses above alarm codes (1st and/or 2nd code) BFSK - "ALARM" then 2nd code (1st if 2nd blank)</p> <p style="text-align: center;"><u>ALARMS, BANKS 3 THROUGH 8</u></p> <p>PULSE- Event Code then position of zone (1-8) BFSK - "ALARM" then position of zone (1-8)</p> <p style="text-align: center;"><u>TROUBLES, BANKS 1, 2</u></p> <p>PULSE- Event Code then 2nd code (1st if 2nd blank) BFSK - "TROUBLE" then 2nd code (1st if 2nd blank)</p> <p style="text-align: center;"><u>TROUBLES, BANKS 3 THROUGH 8</u></p> <p>PULSE- Event Code then position of zone (1-8) BFSK - "TROUBLE" then position of zone (1-8)</p> <p style="text-align: center;"><u>RESTORES, BANKS 0, 1, 2</u></p> <p>PULSE- Event Code then 2nd code (1st if 2nd blank) BFSK - "RESTORE" then 2nd code (1st if 2nd blank)</p> <p style="text-align: center;"><u>RESTORES, BANKS 3 THROUGH 8</u></p> <p>PULSE- restore Event Code then position of zone (1-8) BFSK - "RESTORE" then by position of zone (1-8)</p> <p style="text-align: center;"><u>TROUBLE RESTORES, BANKS 1, 2</u></p> <p>PULSE- restore Event Code then trouble Event Code BFSK - "RESTORE" then 2nd code (1st if 2nd blank)</p> <p style="text-align: center;"><u>TROUBLE RESTORES, BANKS 3 THROUGH 8</u></p> <p>PULSE restore Event Code then trouble Event Code BFSK - "RESTORE" then position of zone (1-8)</p>
--	---

## MA2600 KEYPAD PROGRAMMING SHEET

### ZONE FEATURES

FEATURE	RANK TWO					RANK ONE					RANK ZERO																
	ZONE		ZONE			ZONE		ZONE			AC	LB	PA	ADDR	AM	FT	F2	F1									
	16	15	14	13	ADDR	12	11	10	9	8									7	6	5	ADDR	4	3	2	1	
LOOP RESPONSE 50ms	8	4	2	1	624	8	4	2	1	8	4	2	1	576	8	4	2	1	*	*	*	*	528	*	*	*	*
LOOP RESPONSE 10ms	8	4	2	1	625	8	4	2	1	8	4	2	1	577	8	4	2	1	*	*	*	*	529	*	*	*	*
PRIORITY ZONE	(8)	(4)	(2)	(1)	626	(8)	(4)	(2)	(1)	(8)	(4)	(2)	(1)	578	(8)	(4)	(2)	(1)	4	2	1		530	*	4	2	1
PRIORITY WITH BYPASS	8	4	2	1	627	8	4	2	1	8	4	2	1	579	8	4	2	1	4	2	1		531	*	4	2	1
AUTO BYPASS	8	4	2	1	628	8	4	2	1	8	4	2	1	580	8	4	2	1	*	*	*	*	532	*	*	*	*
SELECTIVE BYPASS	(8)	(4)	(2)	(1)	629	(8)	(4)	(2)	(1)	(8)	(4)	(2)	(1)	581	(8)	(4)	(2)	(1)	*	*	*	*	533	*	*	*	*
GROUP (INTERIOR) BYPASS	8	4	2	1	630	8	4	2	1	8	4	2	1	582	8	4	2	1	*	*	*	*	534	*	*	*	*
24-HOUR PROTECTION	8	4	2	1	631	8	4	2	1	8	4	2	1	583	8	4	2	1	*	*	*	*	535	*	*	*	*
SWEEP SIREN	(8)	(4)	(2)	(1)	632	(8)	(4)	(2)	(1)	(8)	(4)	(2)	(1)	584	(8)	(4)	(2)	(1)	4	2	1		536	*	4	2	1
PULSE-SWEEP SIREN	8	4	2	1	633	8	4	2	1	8	4	2	1	585	8	4	2	1	4	2	(1)		537	*	4	2	1
STEADY SIREN	8	4	2	1	634	8	4	2	1	8	4	2	1	586	8	4	2	1	4	2	1		538	*	4	(2)	(1)
RELAY OUTPUT 1	8	4	2	1	635	8	4	2	1	8	4	2	1	587	8	4	2	1	4	2	1		539	*	4	2	1
RELAY OUTPUT 2	8	4	2	1	636	8	4	2	1	8	4	2	1	588	8	4	2	1	4	2	1		540	*	4	2	1
EXIT/ENTRY 1	8	4	2	1	637	8	4	2	1	8	4	2	1	589	8	4	2	(1)	*	*	*	*	541	*	*	*	*
EXIT/ENTRY 2	8	4	2	1	638	8	4	2	1	8	4	2	1	590	8	4	2	1	*	*	*	*	542	*	*	*	*
E/E FOLLOWER	8	4	2	1	639	8	4	2	1	8	4	2	1	591	8	4	2	1	*	*	*	*	543	*	*	*	*
AUTO RESET	(8)	(4)	(2)	(1)	640	(8)	(4)	(2)	(1)	(8)	(4)	(2)	(1)	592	(8)	(4)	(2)	(1)	*	*	*	*	544	*	*	*	*
SWINGER SHUTDOWN	(8)	(4)	(2)	(1)	641	(8)	(4)	(2)	(1)	(8)	(4)	(2)	(1)	593	(8)	(4)	(2)	(1)	*	*	*	*	545	*	*	*	*
CHIME	8	4	2	1	642	8	4	2	1	8	4	2	1	594	8	4	2	(1)	*	*	*	*	546	*	*	*	*
ABORT DELAY	8	4	2	1	643	8	4	2	1	8	4	2	1	595	8	4	2	1	*	*	*	*	547	*	4	2	1
POWER-UP DELAY	8	4	2	1	644	8	4	2	1	8	4	2	1	596	8	4	2	1	*	*	*	*	548	*	*	*	*
DAY ZONE OPEN	8	4	2	1	645	8	4	2	1	8	4	2	1	597	8	4	2	1	*	*	*	*	549	*	*	*	*
DAY ZONE SHORT	8	4	2	1	646	8	4	2	1	8	4	2	1	598	8	4	2	1	*	*	*	*	550	*	*	*	*
ALARM ON DAY ZONE	8	4	2	1	647	8	4	2	1	8	4	2	1	599	8	4	2	1	*	*	*	*	551	*	*	*	*
REPUKI TELCO 1																											
ALARM	8	4	2	1	648	8	4	2	1	8	4	2	1	600	8	4	2	1	4	2	1		552	8	4	2	1
ALARM RESTORE	8	4	2	1	649	8	4	2	1	8	4	2	1	601	8	4	2	1	4	2	1		553	*	4	2	1
TROUBLE	8	4	2	1	650	8	4	2	1	8	4	2	1	602	8	4	2	1	*	*	*	*	554	*	*	*	*
TROUBLE RESTORE	8	4	2	1	651	8	4	2	1	8	4	2	1	603	8	4	2	1	*	*	*	*	555	*	*	*	*
REPORT TELCO 3 (DOUBLE OR SPLIT REPORTING)																											
ALARM	8	4	2	1	656	8	4	2	1	8	4	2	1	608	8	4	2	1	4	2	1		560	8	4	2	1
ALARM RESTORE	8	4	2	1	657	8	4	2	1	8	4	2	1	609	8	4	2	1	4	2	1		561	*	4	2	1
TROUBLE	8	4	2	1	658	8	4	2	1	8	4	2	1	610	8	4	2	1	*	*	*	*	562	*	*	*	*
TROUBLE RESTORE	8	4	2	1	659	8	4	2	1	8	4	2	1	611	8	4	2	1	*	*	*	*	563	*	*	*	*
NO EOL RESISTOR	8	4	2	1	660	8	4	2	1	8	4	2	1	612	8	4	2	1									
PIR SUPERVISION	8	4	2	1	661	8	4	2	1	8	4	2	1	613	8	4	2	1									
TROUBLE ON OPEN	8	4	2	1	662	8	4	2	1	8	4	2	1	614	8	4	2	1									
TROUBLE ON SHORT	8	4	2	1	663	8	4	2	1	8	4	2	1	615	8	4	2	1									
TROUBLE ON NIGHT OPEN	8	4	2	1	664	8	4	2	1	8	4	2	1	616	8	4	2	1									

### USERS OPENING/CLOSING

	USER				USER				USER				USER					
	*	15	14	13	ADDR	12	11	10	9	8	7	6	5	ADDR	4	3	2	1
CLOSING REPT TELCO 1	*	4	2	1	565	8	4	2	1	8	4	2	1	564	8	4	2	1
OPENING REPT TELCO 1	*	4	2	1	567	8	4	2	1	8	4	2	1	566	8	4	2	1
CLOSING REPT TELCO 3	*	4	2	1	573	8	4	2	1	8	4	2	1	572	8	4	2	1
OPENING REPT TELCO 3	*	4	2	1	575	8	4	2	1	8	4	2	1	574	8	4	2	1

**MA2600 KEYPAD PROGRAMMING SHEET**

FEATURE	BANK FIVE					BANK FOUR					BANK THREE																		
	POSITION		ADDR	POSITION		POSITION		ADDR	POSITION		POSITION		ADDR	POSITION															
	8	7		6	5	4	3		2	1	8	7		6	5	4	3	2	1	8	7	6	5	4	3	2	1		
ZONE	40	39	38	37	ZONE	36	35	34	33	ZONE	32	31	30	29	ZONE	28	27	26	25	ZONE	24	23	22	21	ZONE	20	19	18	17
PRIORITY ZONE	8	4	2	1	770	8	4	2	1	722	8	4	2	1	674	8	4	2	1										
PRIORITY WITH BYPASS	8	4	2	1	771	8	4	2	1	723	8	4	2	1	675	8	4	2	1										
AUTO BYPASS	8	4	2	1	772	8	4	2	1	724	8	4	2	1	676	8	4	2	1										
SELECTIVE BYPASS	8	4	2	1	773	8	4	2	1	725	8	4	2	1	677	8	4	2	1										
GROUP (INTERIOR) BYPASS	8	4	2	1	774	8	4	2	1	726	8	4	2	1	678	8	4	2	1										
24-HOUR PROTECTION	8	4	2	1	775	8	4	2	1	727	8	4	2	1	679	8	4	2	1										
SWEEP SIREN	8	4	2	1	776	8	4	2	1	728	8	4	2	1	680	8	4	2	1										
PULSE-SWEEP SIREN	8	4	2	1	777	8	4	2	1	729	8	4	2	1	681	8	4	2	1										
STEADY SIREN	8	4	2	1	778	8	4	2	1	730	8	4	2	1	682	8	4	2	1										
RELAY OUTPUT 1	8	4	2	1	779	8	4	2	1	731	8	4	2	1	683	8	4	2	1										
RELAY OUTPUT 2	8	4	2	1	780	8	4	2	1	732	8	4	2	1	684	8	4	2	1										
EXIT/ENTRY 1	8	4	2	1	781	8	4	2	1	733	8	4	2	1	685	8	4	2	1										
EXIT/ENTRY 2	8	4	2	1	782	8	4	2	1	734	8	4	2	1	686	8	4	2	1										
E/E FOLLOWER	8	4	2	1	783	8	4	2	1	735	8	4	2	1	687	8	4	2	1										
AUTO RESET	8	4	2	1	784	8	4	2	1	736	8	4	2	1	688	8	4	2	1										
SWINGER SHUTDOWN	8	4	2	1	785	8	4	2	1	737	8	4	2	1	689	8	4	2	1										
CHIME	8	4	2	1	786	8	4	2	1	738	8	4	2	1	690	8	4	2	1										
ABORT DELAY	8	4	2	1	787	8	4	2	1	739	8	4	2	1	691	8	4	2	1										
POWER-UP DELAY	8	4	2	1	788	8	4	2	1	740	8	4	2	1	692	8	4	2	1										
DAY ZONE OPEN	8	4	2	1	789	8	4	2	1	741	8	4	2	1	693	8	4	2	1										
DAY ZONE SHORT	8	4	2	1	790	8	4	2	1	742	8	4	2	1	694	8	4	2	1										
ALARM ON DAY ZONE	8	4	2	1	791	8	4	2	1	743	8	4	2	1	695	8	4	2	1										
REPORT TELCO 1																													
ALARM	8	4	2	1	792	8	4	2	1	744	8	4	2	1	696	8	4	2	1										
ALARM RESTORE	8	4	2	1	793	8	4	2	1	745	8	4	2	1	697	8	4	2	1										
TROUBLE	8	4	2	1	794	8	4	2	1	746	8	4	2	1	698	8	4	2	1										
TROUBLE RESTORE	8	4	2	1	795	8	4	2	1	747	8	4	2	1	699	8	4	2	1										
REPORT TELCO 3 (DOUBLE OR SPLIT REPORTING)																													
ALARM	8	4	2	1	800	8	4	2	1	752	8	4	2	1	704	8	4	2	1										
ALARM RESTORE	8	4	2	1	801	8	4	2	1	753	8	4	2	1	705	8	4	2	1										
TROUBLE	8	4	2	1	802	8	4	2	1	754	8	4	2	1	706	8	4	2	1										
TROUBLE RESTORE	8	4	2	1	803	8	4	2	1	755	8	4	2	1	707	8	4	2	1										
NO EOL RESISTOR	8	4	2	1	804	8	4	2	1	756	8	4	2	1	708	8	4	2	1										
PIR SUPERVISION	8	4	2	1	805	8	4	2	1	757	8	4	2	1	709	8	4	2	1										
TROUBLE ON OPEN	8	4	2	1	806	8	4	2	1	758	8	4	2	1	710	8	4	2	1										
TROUBLE ON SHORT	8	4	2	1	807	8	4	2	1	759	8	4	2	1	711	8	4	2	1										
TROUBLE ON NIGHT OPEN	8	4	2	1	808	8	4	2	1	760	8	4	2	1	712	8	4	2	1										

**MA2600 KEYPAD PROGRAMMING SHEET**

FEATURE	BANK EIGHT				BANK SEVEN				BANK SIX			
	POSITION		ADDR	POSITION		POSITION		ADDR	POSITION		POSITION	
	8 7 6 5	4 3 2 1		8 7 6 5	4 3 2 1	8 7 6 5	4 3 2 1		8 7 6 5	4 3 2 1		
ZONE	ZONE	ZONE	ZONE	ZONE	ZONE	ZONE	ZONE	ZONE	ZONE	ZONE	ZONE	
	64 63 62 61		60 59 58 57	56 55 54 53	ADDR	52 51 50 49	48 47 46 45	ADDR	44 43 42 41			
PRIORITY ZONE	8 4 2 1	914	8 4 2 1	8 4 2 1	866	8 4 2 1	8 4 2 1	818	8 4 2 1			
PRIORITY WITH BYPASS	8 4 2 1	915	8 4 2 1	8 4 2 1	867	8 4 2 1	8 4 2 1	819	8 4 2 1			
AUTO BYPASS	8 4 2 1	916	8 4 2 1	8 4 2 1	868	8 4 2 1	8 4 2 1	820	8 4 2 1			
SELECTIVE BYPASS	8 4 2 1	917	8 4 2 1	8 4 2 1	869	8 4 2 1	8 4 2 1	821	8 4 2 1			
GROUP (INTERIOR) BYPASS	8 4 2 1	918	8 4 2 1	8 4 2 1	870	8 4 2 1	8 4 2 1	822	8 4 2 1			
24-HOUR PROTECTION	8 4 2 1	919	8 4 2 1	8 4 2 1	871	8 4 2 1	8 4 2 1	823	8 4 2 1			
SWEEP SIREN	8 4 2 1	920	8 4 2 1	8 4 2 1	872	8 4 2 1	8 4 2 1	824	8 4 2 1			
PULSE-SWEEP SIREN	8 4 2 1	921	8 4 2 1	8 4 2 1	873	8 4 2 1	8 4 2 1	825	8 4 2 1			
STEADY SIREN	8 4 2 1	922	8 4 2 1	8 4 2 1	874	8 4 2 1	8 4 2 1	826	8 4 2 1			
RELAY OUTPUT 1	8 4 2 1	923	8 4 2 1	8 4 2 1	875	8 4 2 1	8 4 2 1	827	8 4 2 1			
RELAY OUTPUT 2	8 4 2 1	924	8 4 2 1	8 4 2 1	876	8 4 2 1	8 4 2 1	828	8 4 2 1			
EXIT/ENTRY 1	8 4 2 1	925	8 4 2 1	8 4 2 1	877	8 4 2 1	8 4 2 1	829	8 4 2 1			
EXIT/ENTRY 2	8 4 2 1	926	8 4 2 1	8 4 2 1	878	8 4 2 1	8 4 2 1	830	8 4 2 1			
E/E FOLLOWER	8 4 2 1	927	8 4 2 1	8 4 2 1	879	8 4 2 1	8 4 2 1	831	8 4 2 1			
AUTO RESET	8 4 2 1	928	8 4 2 1	8 4 2 1	880	8 4 2 1	8 4 2 1	832	8 4 2 1			
SWINGER SHUTDOWN	8 4 2 1	929	8 4 2 1	8 4 2 1	881	8 4 2 1	8 4 2 1	833	8 4 2 1			
CHIME	8 4 2 1	930	8 4 2 1	8 4 2 1	882	8 4 2 1	8 4 2 1	834	8 4 2 1			
ABORT DELAY	8 4 2 1	931	8 4 2 1	8 4 2 1	883	8 4 2 1	8 4 2 1	835	8 4 2 1			
POWER-UP DELAY	8 4 2 1	932	8 4 2 1	8 4 2 1	884	8 4 2 1	8 4 2 1	836	8 4 2 1			
DAY ZONE OPEN	8 4 2 1	933	8 4 2 1	8 4 2 1	885	8 4 2 1	8 4 2 1	837	8 4 2 1			
DAY ZONE SHORT	8 4 2 1	934	8 4 2 1	8 4 2 1	886	8 4 2 1	8 4 2 1	838	8 4 2 1			
ALARM ON DAY ZONE	8 4 2 1	935	8 4 2 1	8 4 2 1	887	8 4 2 1	8 4 2 1	839	8 4 2 1			
REPORT TELCO 1												
ALARM	8 4 2 1	936	8 4 2 1	8 4 2 1	888	8 4 2 1	8 4 2 1	840	8 4 2 1			
ALARM RESTORE	8 4 2 1	937	8 4 2 1	8 4 2 1	889	8 4 2 1	8 4 2 1	841	8 4 2 1			
TROUBLE	8 4 2 1	938	8 4 2 1	8 4 2 1	890	8 4 2 1	8 4 2 1	842	8 4 2 1			
TROUBLE RESTORE	8 4 2 1	939	8 4 2 1	8 4 2 1	891	8 4 2 1	8 4 2 1	843	8 4 2 1			
REPORT TELCO 3 (DOUBLE OR SPLIT REPORTING)												
ALARM	8 4 2 1	944	8 4 2 1	8 4 2 1	896	8 4 2 1	8 4 2 1	848	8 4 2 1			
ALARM RESTORE	8 4 2 1	945	8 4 2 1	8 4 2 1	897	8 4 2 1	8 4 2 1	849	8 4 2 1			
TROUBLE	8 4 2 1	946	8 4 2 1	8 4 2 1	898	8 4 2 1	8 4 2 1	850	8 4 2 1			
TROUBLE RESTORE	8 4 2 1	947	8 4 2 1	8 4 2 1	899	8 4 2 1	8 4 2 1	851	8 4 2 1			
NO EOL RESISTOR	8 4 2 1	948	8 4 2 1	8 4 2 1	900	8 4 2 1	8 4 2 1	852	8 4 2 1			
PIR SUPERVISION	8 4 2 1	949	8 4 2 1	8 4 2 1	901	8 4 2 1	8 4 2 1	853	8 4 2 1			
TROUBLE ON OPEN	8 4 2 1	950	8 4 2 1	8 4 2 1	902	8 4 2 1	8 4 2 1	854	8 4 2 1			
TROUBLE ON SHORT	8 4 2 1	951	8 4 2 1	8 4 2 1	903	8 4 2 1	8 4 2 1	855	8 4 2 1			
TROUBLE ON NIGHT OPEN	8 4 2 1	952	8 4 2 1	8 4 2 1	904	8 4 2 1	8 4 2 1	856	8 4 2 1			

## MA2600 KEYPAD PROGRAMMING SHEET

455		
		(4)
RESET TEST TIMER ON ANY REPORT	1	1
ACTIVATE ZONE 14 ON EZM TAMPER	2	2
(RESERVED)	4	(4)
(RESERVED)	8	8

TEST TIMER POWER-UP OFFSET (HOURS)	456		457	TEST TIMER REPORT INTERVAL (DAYS)
	x16	x1	x16	x1

969		
DISABLE FUNCTION-8 DOWNLOAD	1	1
DISABLE CALLBACK DOWNLOAD	2	2
DISABLE CARRIER DOWNLOAD	4	4
DISABLE AUTO-RESET ON DAY ZONE	8	8

970		
		(2)
ACCESS CONTROL ON RELAY OUTPUT 2	1	1
EASY ARM WITH ON/OFF BUTTON	2	(2)
REPORT SERVICE CODE AS USER 15	4	4
START EXIT DELAY AFTER RINGBACK	8	8

971		
		(D)
ENABLE RED BUTTONS AS FIRE ZONE	(1)	1
ENABLE GREEN BUTTONS AS ZONE 15	2	2
ENABLE BLUE BUTTONS AS PANIC	(4)	4
ENABLE TELCO TEST ON KEYPAD TEST	(8)	8

TIME-OUTS		x16	x1
RELAY OUTPUT 1 TIME (MINUTES)	960		
RELAY OUTPUT 2 TIME (MINUTES)	961		
RELAY OUTPUT 2 ACCESS CONTROL TIME (SECONDS)	962		
SWEEP SIREN TIME (MINUTES)	963		
PULSE-SWEEP SIREN TIME (MINUTES)	964		(.,F)
STEADY SIREN TIME (MINUTES)	965		(.,F)
ABORT DELAY TIME (SECONDS)	966		(.,F)
CHIME TIME (SECONDS)	967		
AC FAIL REPORT DELAY (MINUTES)	968		(.,2)
PIR SUPERVISION (24 DISARMED HOURS)	969		(4.,)

CLEAR SHUTDOWN MESSAGE	990
NUMBER OF RINGS BEFORE CALLBACK (3 TO 15)	993
NUMBER OF KEYPADS	995
NUMBER OF EZM GROUPS (4 ZONES = 1 GROUP)	996
CLEAR DEALER PROGRAM	997
LOAD DEFAULT PROGRAM	998
*LOAD PROM	999

\*NOTE: LOADING DATA FROM A PROM WILL ERASE PREVIOUS PROGRAMMING EXCEPT FOR THOSE FEATURES/CODES NOT PROGRAMMABLE BY PROM.



#### 4. GLOSSARY & PROGRAMMING INFORMATION

**NOTE:** Refer to the Keypad Programming Sheets for address numbers. Refer to the PROM Programming Sheets for location numbers (be sure to observe PROM page number).

##### Abort Delay

A delay period that allows cancellation of the central-station report. This is done by disarming the control panel within the delay period. Program zones for Abort Delay; see Time Selection for delay time.

**NOTE:** If Abort Delay is selected for a 24-Hour Zone, the zone must be cleared before disarming the panel.

##### Ac Failure

If ac power is removed from the control panel, the SYSTEM TROUBLE LED will come on and [CHECK TROUBLE] will appear in the display. To arm, first check the system trouble; the display will read [\*SYSTEM READY\* ], but the LED will remain lit. If an Arm/Disarm Code is entered within 5 minutes, the panel may be armed successfully. (If programmed for Priority with Bypass, also press the [RESET] Button prior to arming.)

Ac Failure may be programmed to activate any alarm output. An alarm and/or restore report to the central station will occur immediately unless an Ac-Fail Report Delay is programmed. See Time Selection.

##### Access Control on Relay 2

If selected, entering the Access Code while disarmed will trip Relay 2. This is commonly used to activate a door striker for the purposes of remotely unlocking a door. Also program Relay-2 Output Access Control Time (see Time Selection).

##### Access Number for Outside Line

Some subscribers will have a telephone system that requires one digit to access an outside line before the telephone number can be dialed. Also, the first dial tone encountered (prior to the access number) may have a frequency that is different from that of the accessed dial tone (440Hz). One or more 4-second Pre-Dial Delay "D"s may be entered before the access number instead of a dial tone with frequency "E". See Pre-Dial Delay; Telephone Numbers.

If the subscriber's system uses an access number, contact the telephone-equipment supplier to find out if a dial tone other than 440Hz is received prior to dialing the access number. If the communicator must delay before dialing the access number instead

of attempting to recognize the dial tone, find out how many 4-second delays must be programmed.

**Activate Zone 14 On EZM Tamper** (Required for U.L. installations.)

When selected, removing the cover of an EZM module will activate Zone 14, which can be programmed for reporting and/or alarm outputs. When the cover is removed, the sounder will beep repeatedly, the SYSTEM TROUBLE LED will come on, and the display will read [ TAMPER ], then [ ZONE MODULE XX]. Press the [RESET] Button to silence the sounder. Arm and disarm to reset the TAMPER display. The display will now read [ CHECK TROUBLE ]. To arm, check and correct the trouble.

**Alarm History**

With the RP2600 keypad cover raised, press [DISPLAY], then Key [3] to display past alarm conditions. Alarm History comprises four memories. Alarm History #1 contains all the alarms that have occurred since the panel was last armed. Alarm History #2 contains the alarms that occurred during the previous arm/disarm interval; Alarm History #3 the next arm/disarm interval, etc. Alarm History #1 always contains the most recent alarm(s).

**Alarm On Day Zone** See Day Zone

**Alarm Outputs**

The MA2600LK has an integral siren driver for both burglary and fire alarms, two Form-C dry relay contact outputs, and a communicator that can report alarms to a central station. A bell may be used on the siren output terminals if Jumper E is cut.

The following table summarizes wiring for signalling an alarm in typical installations. See Time Selection for time-out durations.

Output	Wiring	Remarks
Sweep Siren*	Speaker on 47, 48	See Note below
Steady Siren*	Speaker on 47, 48	
Pulsing Sweep Siren*	Speaker on 47, 48	
Steady Bell*	Bell on 47(-), 48(+)	Cut Jumper E for bell
Pulsing Bell*	Bell on 47(-), 48(+)	Cut Jumper E for bell
Relay Output #1	6(C), 7(N/O) 8(N/C)	
Relay Output #2	3(C); 4(N/O) 5(N/C)	
Relay #1 as Smoke Reset	6(C) 8(N/C)	Connect to AUX PWR (+) (Term. 12) Connect to smoke det. power (+)
*In U.L. installations, see Time Selection for time-out requirements.		

**NOTE:** Cut Jumper D to produce a two-tone alternating siren sound; cut Jumper C to prevent the fire signal from sounding a steady siren. For Speaker/Bell Output, connect one or two (in parallel) 8-ohm, 15-watt speakers across Terminals 47 (-) and 48 (+).

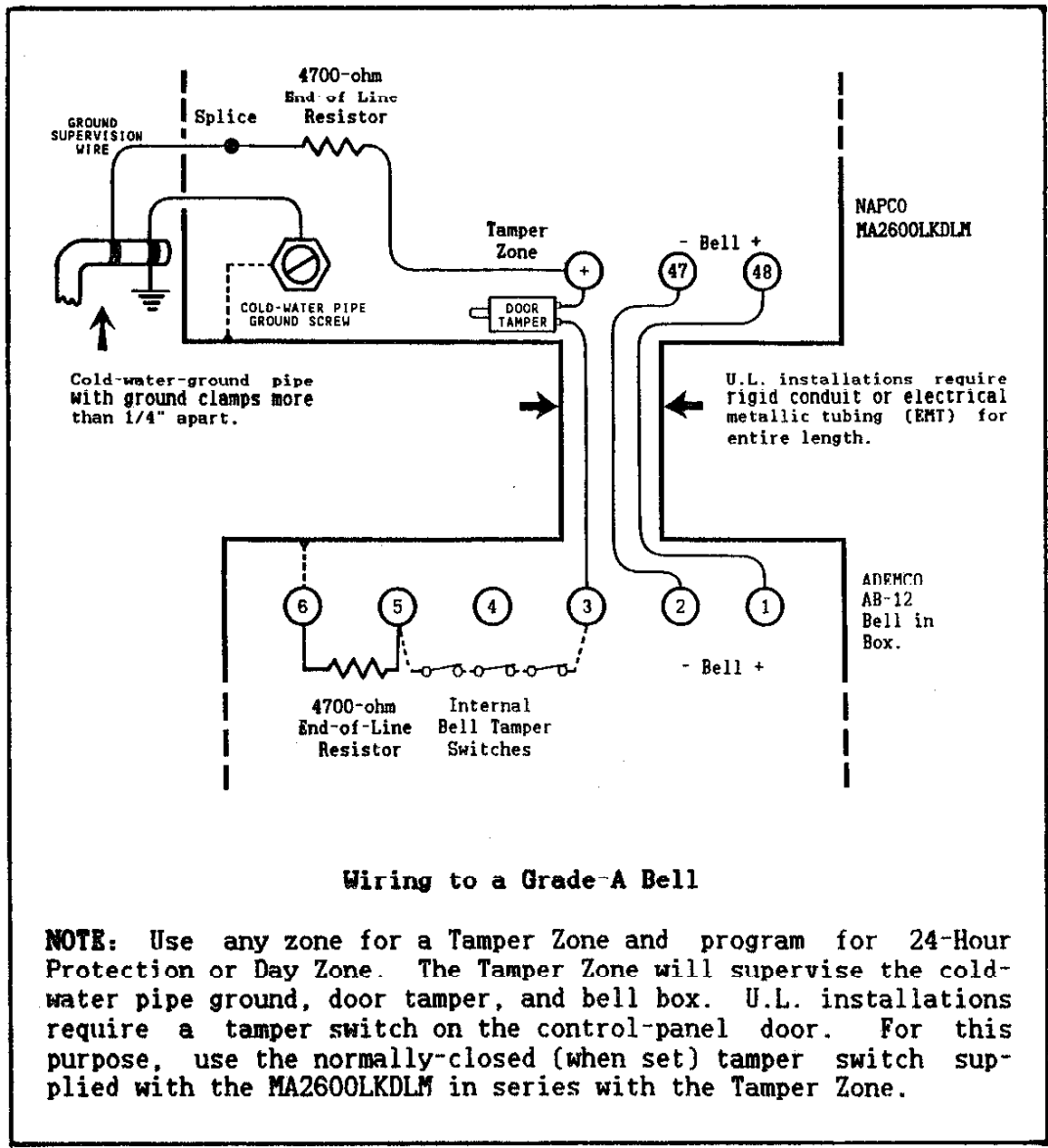

Ambush Code

A 2-digit code that is entered immediately prior to (and as part of) the regular Arm/Disarm Code. This will access the Ambush Zone, causing a silent report to be sent to a central station. Thus, should a user be forced to disarm by an assailant, he can silently signal an emergency while appearing to be merely disarming the system. The Ambush Zone will automatically report when programmed to report on alarm.

To program the ambush feature, (a) program Ambush to report on alarm; (b) enter 2 digits as the Ambush Code; and (c) enter an Ambush-Zone Alarm Report Code.

Inform the user what the Ambush Code is, and that his Arm/Disarm Code must be entered less than 10 seconds after the Ambush Code for an ambush report to be sent.

#### Anti-Jam Time

If the communicator does not detect a dial tone within 12 seconds, the Anti-Jam feature will be activated. That is, the communicator will go off line for a 16-second anti-jam interval in order to free the telephone circuit from an incoming call, then make another 12-second attempt at dial-tone detection. If still unsuccessful, the communicator will again go off line for 16 seconds, then proceed to dial anyway.

If a longer time is required for the Anti-Jam feature to function, change the anti-jam interval from 16 seconds: access address 453 (not on programming sheet) and program up to 15 additional seconds in the right-hand display segment. To test the Anti-Jam feature, call the alarm phone line from a different phone line, then activate an alarm. The incoming call should be disconnected by the control panel.

#### Arm Lug (Lug E4)

Lug E4 (ARM) will go to OVdc when the system is armed. This lug may be used for auxiliary equipment. (For use, refer to the instructions furnished with the device.) The ARM Lug has been tested by UL for use with Napco's M7000-Series and M9000-Series Monitor (TM) Double Tech (R) sensors. Refer to WI464 and WI492, respectively, for installation. A maximum of 10 units can be connected a distance of up to 1000 feet using #22AWG wire.

#### Auto Bell Test Upon Arming (Required for UL Mercantile installations.)

This will activate the speaker/bell output briefly 10 seconds after the control panel is armed. If the alarm does not sound, the device may be defective.

#### Auto-Bypass (Do not program for UL installations.)

Zones programmed for Auto-Bypass will be bypassed (automatically removed) if in trouble when arming. A momentary beep will sound at the keypad to warn that the system has been armed without the protection of the auto-bypassed zone. (Note that the exit/entry door must be closed before arming, otherwise the Exit/Entry Zone will be auto-bypassed.)

NOTE: A zone in trouble that is not programmed for Auto-Bypass will cause an alarm on arming after a 10-second arming delay. If programming Priority with Bypass, Auto-Bypass is automatically

selected.

### Auto-Reset

If a zone signals an alarm and is selected for Auto-Reset, it will automatically rearm itself as soon as the alarm condition is cleared. Auto-Reset may be delayed to occur after the sweep-siren time-out period by selecting Auto-Reset After Sweep-Siren Time-Out and Auto-Reset. Zones 1 through 64 that are *not* programmed for Auto-Reset will not be capable of signalling another alarm until (a) the cause of the alarm has been cleared and (b) the control panel is disarmed. Also see Swinger Shutdown.

Auto-Reset After Sweep-Siren Time-Out See Auto-Reset

### Backup Reporting Telco 1, 2

If Backup Reporting is selected and the communicator does not reach the first telephone number after two attempts, seven attempts will be made to reach the second telephone number. Enter Subscriber Identification Numbers for Telephone 2 and other information required for Telephone 2. Also program Backup Reporting Telco 1, 2. Any zone programmed to report to Telco 1 will backup report to Telco 2.

NOTE: Subscriber Identification Numbers for both Telephones 1 and 2 *must* be entered, even if they are the same.

### Bank

A group of zones. The MA2600LK is divided into 3 banks arranged as follows:

- Bank 0: Fire 1; Fire 2; Fire Trouble; Ambush; Panic; Low Battery; Ac Fail
- Bank 1: Zones 1-8
- Bank 2: Zones 9-16

NOTE: banks 3 through 8 are available for expansion-zone modules. Bank 0, Position 2 is not used.

### Battery

12Vdc standby power source in the control panel to provide backup protection in the event of a power loss. NAPCO's RBAT4 (optional) is rated at 4 ampere-hours, the RBAT6 (optional) at 6 ampere-hours. The battery is an integral part of the system and *must* be installed, even if ac power is present. Change the battery every 5 years or as required.

A lithium battery (supplied) provides additional backup for pro-

gramming memory. Before installation, check terminal voltage; it should measure at least 2.75Vdc. The estimated life of the lithium battery is 5 years.

Burglary Lug (Lug E10) See Sweep Lug

Burglary Output See Alarm Outputs

Call Waiting See Disable Call Waiting

Callback-Method Download

Disable Callback Download (Required for UL installations)

Disable Carrier Download (Required for UL installations)

Number of Rings Before Callback

Data may be remotely downloaded to an MA2600LKDL after a programmed number of rings (3 to 15) and a control-panel confirmation callback. Program the number of rings in Location 993. (If Location 993 is not programmed, the panel will call back after 15 rings).

This method will accommodate an answering machine at the site if line seizure is used on the house phones. (Be sure that Disable Carrier Download is not programmed.) The answering machine will pick up on its programmed number of rings, as usual. The control panel will then listen for the signal from the PCD2000 software and seize the line from the house phones and the connection will subsequently be established.

NOTE: The number of rings programmed into the panel (Location 993) must exceed that of the answering machine.

Program Disable Callback Download to prevent unauthorized downloading to an unattended panel. (This feature must be programmed for all UL installations.)

Program Disable Carrier Download to inhibit downloading to a telephone connected to an answering machine. (This feature must be programmed for all UL installations.)

Chime

This annunciator feature may be used on any zone to sound a tone at the keypad while disarmed when the zone goes into trouble. Access Function 4 to enable or disable the Chime Mode. This feature is programmable for zone and for duration of tone (see Time Selection). A time must be programmed for the chime to function.

Closing Report  
Closing Report Only on Force Arm  
Force Arm  
Include Selective/Group Bypass In Force Arm/Status  
Status Report

On arming, the communicator can transmit a Closing Code for each user, a Force Arm Code, and a status report that identifies the problem zone to the central station. Note that Subscriber Identification Numbers and a Closing Code *must* be entered for any closing report.

Select which users will report closings for each telephone number, even if Closing Report Only on Force Arm is selected. Normally, a closing report will consist of the Closing Code and the number of the user that armed. If the user armed with an auto-bypassed zone (or selective/group bypassed zone if Include Selective/Group Bypass In Force Arm/Status was programmed), the Force Arm Code will also be sent. If a Force Arm Code is not sent, leave it blank.

Select Closing Report Only on Force Arm to report *only* when arming with an auto-bypassed zone (and selective-/group-bypassed zone if Include Selective/Group Bypass in Force Arm/Status is programmed). This transmission will consist of a closing report followed by a Force Arm Code, or just a closing report if the Force Arm Code is blank.

Select Status Report to send a closing followed by a status report that identifies the problem zone(s). The status report will consist of the Trouble/Status Event Code followed by:

Banks 1, 2 - the 2nd digit of the Alarm Code (1st if 2nd blank);  
Banks 3-8 - the position of the zone in the bank.

A typical Status Report is represented by the following example.

*Example.* A burglar breaks into a commercial establishment during the night, breaking the window foil on Zone 5. The Open/Close Subscriber Identification Number is "123"; the Alarm Code for Zone 5 is "3,5" (Burglary Zone 5); the Bank 1 Subscriber Identification Number is "789"; the Closing Code is "C". The communicator will send the following report to the central station.

When alarm occurs:

7893 - Alarm Bank 1.  
3335 - Bank 1, Zone 5.

Closing Report:

123C - Closing: User returned; inspected damage; rearmed.  
CCC1 - Closing: User 1  
789F - Trouble Report  
FFF5 - Zone status at time of closing: Window foil still broken. Zone 5 auto-bypasses; repair required.

### Data Format

Consult the central station to find out which of the following formats to use.

**Extended Format.** This is used to transmit two digits for an event yet still use a 3/1 format. The second digit will identify the zone or user. If Two-Digit or Single-Digit data format is not programmed for any telephone number, the format will default to Extended Format, or Single Digit if only one digit is programmed.

**Example.** An installation uses the following programmed transmission information: Subscriber Identification Number is "678"; an alarm is reported for Zone 16. The Alarm Code for Zone 16 is "2,8". The communicator will transmit:

6782 -  
2228 - Alarm on Zone 2-8 (Bank 2, Position 8)

**Single-Digit Event Code Format.** The single digit sent for a particular event can be either the Event Code for the bank or one digit in the Alarm Code (or zone position for Banks 3-8). See Event Codes.

**NOTE:** To have a Single-Digit format for one telephone number and Extended Format for the other, program an Event Code and Alarm Code (Banks 0, 1, and 2) for those zones or events that require Extended Reporting. The telephone number with Single-Digit Reporting will use only the event Code. Where applicable, if either the Event Code or alarm Code is blank, Single-Digit Format will send the one that is entered.

**Two-Digit or 4/2 Format.** Some central-station receivers require that a four-digit Account Code followed by a two-digit Alarm Code be sent in each report.

**Example.** In a certain installation, the Alarm Subscriber Number is "1234"; a burglary alarm occurs on Zone 1. The Alarm Code for Bank-1 Zone 1 is "3,1". The communicator will send "1234 31".

**Sum-Check Format.** Sum Check is a sophisticated data format used to enhance the speed and check the accuracy of the received transmission. This format should be preferred whenever the central station is capable of receiving it.

After transmitting the Subscriber Identification Number and the Alarm Code, the communicator sends a verifying digit that is the sum of both. The receiver compares the verifying digit with the sum of the other numbers to check transmission accuracy.



Day Zone (Open; Short)

Alarm On Day Zone

Disable Auto-Reset On Day Zone

Reset Day Zone With Arm/Disarm Only

Watch On With Function 2

A zone that will give an audible and visual indication at the keypad if there is a problem on the loop while disarmed. Open- and short-circuit conditions are programmed separately, by zone. This feature may be used to warn of a problem (a break in a window foil, for example) during the day, when the panel is not normally armed. When the Day Zone is tripped, the green STATUS LED on the keypad will go off, the sounder will pulse, and the display will indicate the problem zone(s). Press the [RESET] Button to silence the sounder and reset the keypad. Correct the problem to reset the Day Zone. If Reset Day Zone With Arm/Disarm Only is programmed, arm and disarm the panel to reset the audible Day-Zone indication. This added security is useful when using a Day Zone to monitor an entrance.

If Alarm on Day Zone is programmed for a zone, a Day Zone condition will cause the alarm outputs programmed for that zone (sirens, relays) to activate, but only once in any disarmed period.

NOTE: (1) If a zone is programmed for both Day Zone Open and Day Zone Short, either condition must be reset before the other can activate. (2) Day Zone Short is disabled when No EOL Resistor is programmed.

Report Trouble or Trouble Restore is programmed in conjunction with Day Zone Open and Day Zone Short (the trouble reported will be that programmed under Day Zone Open and/or Day Zone Short). To turn off the local Day-Zone indication, program Disable Local Day Zone Indications. See Trouble.

NOTE: Do not program a Day Zone for 24-Hour Protection. The keypad will annunciate as a Day Zone but the panel will transmit an Alarm Code and a Trouble Code when tripped.

Program Disable Auto-Reset On Day Zone to prevent repeated Day-Zone trips. This will cause the keypad display and sounder to activate only once during any arm/disarm period.

If Watch On With Function 2 is selected, zones programmed for Day Zone can only be activated when Function 2 is accessed. (See Section 5.) Arming and disarming will turn off the Watch Mode. If Report Trouble is selected, a trouble on a Day Zone will be reported only when the Watch Mode is on.

Dealer Security Code

Master Security Code

The Dealer Security Code is required to enter the Dealer Program

Mode, thus allowing the dealer to program codes, exit/entry times, zone features, reporting features and zone descriptions (see Section 3). This code may be changed as required. The factory-programmed Master Security Code (printed on the label affixed to the micro can) is unique to each panel, and cannot be changed. If the Dealer Security Code is changed, both the new Dealer Security Code and the Master Security Code will work. However, should the lithium battery fail, only the Master Security Code will work.

*Important!* If the label containing the Master Security Code is removed, the code *must* be recorded in a secure place for reference, as programming changes cannot be made without it (or the new code, if changed).

To change the security code, raise the RP2600 keypad cover and enter the 6-digit Dealer Security Code starting in the left-most location. Closing the cover terminates the Dealer Program Mode and automatically resets the panel.

**NOTE:** If a communication is in progress when the Dealer Program Code is entered, the transmission will terminate.

Default Program See Load Default Program

### Dial-Tone Detection

At least one Dial-Tone Detection entry is usually required for each telephone number used to ensure that a dial tone is present before the communicator dials.

When an "E" is programmed before the first digit of an outside telephone number, the communicator dial-tone detection circuit is set to detect the standard 440Hz dial tone. The "E" is generally entered in the location immediately preceding the telephone number.

It may be necessary to program at least one 4-second Pre-Dial Delay before a Dial-Tone Detection "E". With certain nonstandard exchanges, Pre-Dial-Delay "D"s may be used without a Dial-Tone Detection "E". (See Access Number for Outside Line; Pre-Dial Delay; Telephone Numbers.)

**NOTE:** If the telephone number is not preceded by a "D" or an "E", the communicator will not dial the number.

Disable Auto-Reset On Day Zone see Day Zone

Disable Call Waiting (TouchTone Dialing Only)

A digital communicator connected to a telephone line with Call Waiting may be disrupted by this feature. However, most lines with Call Waiting also have Selective Call Waiting, which permits

the feature to be turned off by dialing a "\*70" just before the telephone number. A "\*" will be dialed by programming a "B".

If the installation has the Call Waiting feature, be sure that it also has Selective Call Waiting, and confirm the disable code with the telephone company. Then program this code ("B70") directly before the phone numbers (after dial-tone detection or pre-dial delay) in the telephone-number locations. See Telephone Numbers.

*Caution:* Should the user cancel his Call Waiting service, the communicator will dial a wrong number unless the phone number is corrected.

Disable Callback Download see Callback-Method Download

Disable Carrier Download see Callback-Method Download

Disable Function-8 Download (Required for UL installations)

Program to prevent manual remote downloading using Function 8 at the panel. See Function 8: MANUAL DOWNLOAD. (This feature is required for all UL installations.)

Disable Smoke Reset on Relay 1

Normally, Relay 1 is used to reset smoke detectors by momentarily removing power when [RESET] is pressed. Zones programmed to activate Relay 1 will do so *only* if Disable Smoke Reset on Relay 1 is selected. See Alarm Outputs.

Double Reporting See Report Telco 3

"E" Lugs (E3, E4, E5, E7, E9, E10, E11, E12, E18)

- E3 - See Ground-Start Module, GSM-400
- E4 - See Arm Lug
- E5 - See Listen-In Module
- E7 - See PS3002 Power-Supply Module Instructions (WI506)
- E9 - See Fire Lug
- E10 - See Burglary Lug
- E11 - See Relay-2 Output
- E12 - See Relay-1 Output
- E18 - See PS3002 Power-Supply Module Instructions (WI506)

Easy Arm With On/Off Button (Not for UL installations)

Permits quick arming by simply pressing the [ON/OFF] Button. Disarming still requires entry of a full code. (A minimum of 3 digits is required in UL installations.)

Enable Blue Keypad Buttons as Panic Zone (RP2600) See Panic Zone

### Enable Green Keypad Buttons as Zone 15 (RP2600)

This feature is used to enable the green keypad buttons for use as an emergency alert. Note that both keypad buttons must be pressed at the same time to activate Zone 15. When enabled, these buttons are automatically programmed for 24-Hour Protection, even if Zone 15 has not been.

### Enable Red Keypad Buttons as Fire Zone (RP2600) See Fire Zones

### Enable Telco Test on Keypad Test

If selected, pressing the small [TEST] Button (under the RP2600 cover, just below Key [0]) will test the telephone line for up to 12 seconds. This test does not send a report to the central station. When the button is released, [TESTING] will appear in the display. If the test is successful, the display will return to normal. Otherwise, the display will read [FAIL, HIT RESET] and a system trouble will be indicated. Press the [RESET] Button; a system trouble display will indicate [TELCO LINE FAIL]. To correct this system trouble, restore the telephone line and repeat the test.

When enabled, and a [FAIL TO COMM] system trouble is displayed, pressing the [TEST] Button will clear the message and the system trouble only if a dial tone is detected. If this feature is not programmed, pressing the [TEST] Button will clear the message whether a dial tone is detected or not.

### Event Codes

There are three types of Event Codes: Alarm, Alarm Restore, and Trouble/Status. If Event Codes are programmed, they will be common for each bank. In Extended or 4/2 format, Event Codes will be sent first, followed by an Alarm Code (Banks 0, 1, and 2) or the position of the zone (Banks 3 through 8). The position of the zone in banks 3 through 8 refers to the sequence of zones in the EZM module. Either the Event Code or the Alarm Codes may be left blank in single-digit format.

Banks 0, 1, and 2. These banks have their own two-digit locations for alarms. Either location may be programmed for single-digit format, or both locations may be programmed for extended or 4/2 format.

Restores on Banks 0, 1, and 2 use the Alarm Restore Event Code followed by the second digit of the bank Alarm Code. If the second digit is blank, the first digit is used.

Trouble/Status Report on Banks 1 and 2 use the Trouble/Status Event Code followed by the second digit of the bank Alarm Code. If the second digit is blank, the first digit is used.

Banks 3-8. These banks do not have their own Alarm Codes. The Event Codes are programmed for each bank. Alarm, restore and trouble/status use the Event Code followed by the position of the zone in the bank. Single-digit format will just use the Event Code. If the Event Code is blank, only the position of the zone in the bank will be transmitted. (In single-digit format, it would be necessary to use different Subscriber I.D. Numbers for each bank to identify the zone.)

Trouble Restore (Banks 1-8). A trouble-restore transmission will consist of the restore Event Code, followed by the trouble/status Event Code, or just the restore Event Code for single-digit format.

NOTE: Event Codes are not used in BFSK receiver format.

#### Exit/Entry Delay

Permits exit and entry through the Exit/Entry Zone(s) after the system is armed without setting off an immediate alarm. Exit delay allows the user to leave the premises after the panel has been armed. Entry delay allows the user time to enter and disarm the panel. Upon entering, the keypad sounder will sound a steady tone to remind the user to disarm the panel.

Two individually-programmable entry-delay times are provided to accommodate different entry zones (one exit delay is sufficient for all). If two or more Exit/Entry Zones are entered in succession, the delay programmed for the last Exit/Entry Zone entered will take precedence over all others.

Exit-Delay time and Entry-Delay time may each be programmed for up to 255 seconds (4-1/4 minutes). See Time Selection.

NOTE: In U.L. installations, Exit-Delay time may not exceed 60 seconds; Entry-Delay time may not exceed 45 seconds.

Exit/entry delay may be cancelled by pressing the [NO DELAY] Button prior to arming, however it will be restored automatically upon disarming. (When armed with *Instant* protection, an "I" will appear at the right side of the display.)

#### Exit/Entry Follower

A zone programmed as an Exit/Entry Follower will ignore detection during the exit delay, and *only* during entry delay if the Exit/Entry Zone is entered *first*. Thus, detection devices (passive infrared detectors, for example) along the path between the keypad and the exit/entry door will not signal an alarm during exit/entry delay under normal conditions. However, if a device in the Exit/Entry Follower Zone detects a violation when the exit/entry door has not first been entered, there will be no entry delay and the Exit/Entry Follower Zone will go into an

instant alarm.

If the panel is armed with the entry delays cancelled (*Instant protection*), any violation on the Exit/Entry Zone or the Exit/Entry Follower Zone will cause an immediate alarm.

#### Expansion Zones

Zones 17 through 64. These individually bypassable zones are added to the basic system using zone expansion modules EZM2004 (4 zones) and/or EZM2008 (8 zones). Refer to WI429 (accompanying each EZM module) for wiring information.

Extended Format See Data Format

Fire Lug (Lug E9) See Steady Lug

#### Fire Zones 1, 2

Enable Red Keypad Buttons as Fire Zone (RP2600)

(Do not program either feature for Mercantile installations.)

Normally-open devices are connected across Fire Zone 1 (Terminals 11 and 10) or Fire Zone 2 (Terminals 9 and 10). A short across either zone will cause a fire alarm, which is indicated by a steady-on red LED and a pulsing keypad sounder. An open circuit on Fire Zone 1 will identify a trouble and cause flashing red LED and pulsing sounder after a 10-second delay. An open circuit on Fire Zone 2 will identify a trouble and cause a flashing red LED and pulsing sounder after a 30-second delay. The sounder may be silenced using the [RESET] Button. The LED will go off within 30 seconds after reset if the alarm or trouble is cleared.

If using smoke detectors on the Fire Zone, use only 4-wire types. Two-wire smoke detectors may not be used. For Smoke-Detector Reset, see Alarm Outputs.

If the Fire Zones are selected to report an alarm or to restore, the Alarm Codes or the Restore Codes will be sent. In order to report a Fire Restore, both Fire Zones must be functional.

If Enable Red Keypad Buttons as Fire Zone is programmed, both red RP2600 keypad buttons must be pressed at the same time to sound a fire alarm. (This will report as Fire Zone 1.)

Force Arm see Closing Report

Ground-Start Module, GSM-400 (Lug E3)

The communicator requires an active phone line, as indicated by

the presence of a dial tone, before it can operate. Although telephone companies currently supply constant on-line dial tone to most customers, some require ground-start voltage actuation to initiate a dial tone on a call-by-call basis.

To provide a ground-start connection to a phone line, the telephone signal line must be momentarily grounded for at least one second to alert the phone equipment for a request for service.

Connection of the GSM-400 module is made at the Ground-Start terminal, Lug E3, on the printed-circuit board. Refer to the installation instructions accompanying the GSM-400 (WI281) for further wiring information.

### Group Bypass

Removal of a preset group of zones from the system. Group bypassing is often used to bypass all interior zones together so that the user may move freely throughout the premises but still be protected from intrusion through armed perimeter zones.

Group bypassing is accomplished by pressing the [INTERIOR OFF] Button. The next time the control panel is disarmed, all bypassed zones will automatically revert to non-bypassed (disarmed) zones.

If group bypassing is selected, the yellow ZONE BYPASSED LED on the RP2600 keypad will light. Display the bypassed zones by pressing the [DISPLAY] Button, then the BYPASSED Button.

Include Selective/Group Bypass In Force Arm/Status See Closing Report

### Interior Normally Bypassed

If this feature is selected, all zones programmed as Group Bypass will always be inactive. The yellow ZONE BYPASSED LED will always be on, indicating that subsequent arming will be with only partial protection. To temporarily restore interior protection, press the [INTERIOR OFF] Button (the ZONE BYPASSED LED will go out). However, the interior (group bypass) zones will once again be bypassed the next time the panel is disarmed.

### Jumpers

Keypad Jumpers (A, B). These are mounted at the lower-left corner of the RP2600 circuit board (as viewed from the front). Jumper A is nearer the corner. Also see Address Jumpers (RP2600 Keypad Assignment), Section 2.

Jumper A: Disable Keypad Panic. Cut Jumper A to disable the blue Keypad Panic Buttons.

**Jumper B: Disable Tactile Beep.** Cut Jumper B to silence the beep that sounds when a keypad button is pressed. (Do not disable in U.L. installations.)

**Control-Panel Jumpers (C, D, E).** These jumpers are located on the control-panel circuit board. Refer to Alarm Outputs for use.

**Keypad Panic** See Panic Zone; Keypad Jumper A

### **Line-Reversal Module, M278**

The Line-Reversal Module allows the control panel to be monitored by a central station through leased lines. On alarm, the module reverses normal line-voltage polarity. For details, refer to the instructions furnished with the module.

### **Listen-In Module (Lug E5)**

If installation requires a Listen-In Module, connect the module to Lug E5. The voltage (12V) at E5 drops to zero when the communicator goes off-hook. When the communicator transmission is completed, the voltage at E5 returns and the Listen-In Module can occupy the phone line.

### **Load Default Program**

The system will automatically load the default program if powered up with an exhausted or missing lithium battery, or upon the unlikely failure of the program stored in memory. To *manually* load the default program, in the Dealer Keypad Program Mode, access address 998 and press the [ON/OFF] Button (SAVE). Following are the default conditions:

- User 1 Arm/Disarm Code: 7, 8, 9
- User Program Code: 1, 2, 3, 4, 5, 6
- Priority: Zones 1-16
- Exit/Entry 1: Zone 1; Entry Delay: 30 sec; Exit Delay: 60 sec.
- Exit/Entry 2: Zone 2; Entry Delay: 30 sec.
- Selective Bypass: Zones 1-16
- Chime: Zone 1; Chime Time: 2 sec.
- Sweep Siren: Zones 1-16; Timeout: 15 min.
- Pulse-Sweep Siren: Panic; Timeout: 15 min.
- Steady Siren: Fire 1, Fire 2; Timeout: 15 min.
- Auto-Reset After Sweep Siren Timeout
- Red Emergency Buttons: Enabled
- Blue Emergency Buttons: Enabled
- Green Emergency Buttons: Disabled
- Telco Test On Keypad Test: Enabled
- TouchTone With Rotary Backup



### Load PROM

Address 999 is used to download the contents of a programmed PROM into memory (in the Dealer Keypad Program Mode). See Section 3: Downloading PROM Data.

### Loop Response (750mS required for UL installations)

Loop response is the amount of time in milliseconds (mS) that a normally-closed circuit must remain open, or a normally-open circuit must remain closed, to trigger an alarm. The slower the loop response, the more immune the system will be to intermittents ("swingers"). Selectable loop-response times are:

750mS (.75 sec.): The slowest loop-response time, recommended for use with magnetic contacts, window foil, etc. Unless programmed otherwise, loop-response time will be 750mS for all zones.

50mS (.05 sec.): Used for momentary Panic Buttons and area-protection devices, such as photoelectric eyes, passive infrared sensors, floor mats, etc.

10mS (.01 sec.): An extremely fast loop response used primarily for window bugs.

NOTE: Loop response for Zones 17-64 is selected at the respective expansion module. Refer to EZM Installation Instructions, WI429.

### Low Battery (Required for UL Mercantile installations)

A low-battery alarm will signal when the battery terminal voltage drops to 11.0V. A low-battery condition may signal a local sounding device, report to a central station, or both.

Master Security Code see Dealer Security Code

### No EOL Resistor

Program for any zone not wired with a 2200-ohm end-of-line resistor. This will disable any short-circuit indication (if programmed, Day Zone Short is disabled). If not programmed, an end-of-line resistor must be installed.

### Number Of EZM Groups

Enter the number of expansion zone groups of 4. Each EZM2004 module comprises 1 group; each EZM2008 module comprises 2 groups. Refer to the installation instructions (WI429, MODULE ASSIGNMENT) furnished with the EZM module for additional information.

Number of Rings Before Callback see Callback-Method Download

Opening Report  
Opening Report Only After Alarm Report

Opening and closing reports are generally used in commercial installations. On disarming, the communicator can send an Opening Code for Users 1-15 (Opening Report), or it may transmit only when the control panel is disarmed after an alarm has been reported (Opening Report Only After Alarm Report). Note that Subscriber Identification Numbers and Opening Codes *must* be entered for either opening report.

Program Opening Report Only After Alarm Report to report only when disarming after an alarm report. This feature may be used by the central station to verify that the subscriber has responded and disarmed the panel. If Opening Report Only After Alarm Report is selected, also select Opening Report for each user.

Panic Zone  
Enable Blue Keypad Buttons as Panic Zone (RP2600)

Wire momentary-contact Panic Buttons to Terminals 42 and 43. If Enable Blue Keypad Buttons as Panic Zone is selected, the Panic Zone is also activated from the blue RP2600 keypad emergency buttons when *both* buttons are pressed at the same time. The Panic Zone is always a 24-Hour Zone. (Also see Keypad Jumper A.)

PIR Supervision  
Sensor Watch

Program for any zone containing a PIR or Double-Tech sensor, floor mats, door contacts, or other device where some activity is expected. This feature supervises the sensor by verifying that the zone activates before the PIR timer runs out. If no trip is detected within the programmed "Sensor-Watch" time, a system trouble will result and [ ACTIVITY FAILURE ] will be displayed at the keypad, followed by the zone number(s). Function 9 will reset this system trouble: press the FUNCTION Button ([BYPASS ZONE]) then Key [9]. To recall the [ ACTIVITY FAILURE ] display, raise the keypad lid and press the [DISPLAY] Button, then Key [4].

Tamper troubles can be reported by zone if a normally-closed tamper switch is wired in series with normally-open alarm relay contacts on a zone. Install the end-of-line resistor across the relay contacts. Program the zone for Trouble On Open.

Program the Sensor-Watch PIR timer in location 992. Select a value according to the expected activity within the coverage area while disarmed. In calculating the Sensor-Watch time, note that only the *disarmed* hours (the time between armed periods) are added. In moderate traffic areas, a Sensor-Watch time of perhaps 1 day may be appropriate, whereas in remote areas, a time of 7 days or more may be in order. Supervision time should be calculated for the supervised zone with the least amount of

traffic. Up to 255 days may be programmed (see Time Selection).

#### Power-Up Delay

If programmed, power-up will be delayed for 5 minutes to allow devices such as PIRs sufficient time to reset (warm up).

#### Power Up In Last State

When programmed, the control panel will return in its last state (armed or disarmed) when (a) the unit is first powered up; (b) the reset switch on the control-panel circuit board is pressed; or (c) ac is restored after a lengthy power failure (and the battery is dead).

NOTE: If the panel returns in an armed state and closings are reported, it will report as User 14.

#### Pre-Dial Delay

A Pre-Dial Delay may be used whenever a delay is required before dialing. It may be required when programming Dial-Tone Detection, which causes the communicator to wait before it attempts to detect a dial tone (see Dial-Tone Detection). Certain telephone exchanges send a nonstandard dial tone that the communicator may not be able to detect. With these nonstandard exchanges, it is possible to program Pre-Dial Delay rather than Dial-Tone Detection. This will cause the communicator to wait for a predetermined period of time before dialing rather than look for a nonstandard dial tone.

Contact the telephone-equipment supplier to find out how long a delay is required before dialing. Select Pre-Dial Delay by programming one "D" for each 4-second delay required immediately before the telephone number.

See Backup Reporting Telco 1, 2; Report Telco 3 (Double or Split Reporting). Also see Access Number for Outside Line; Telephone Numbers.

NOTE: If the telephone number is not preceded by at least one "D" or an "E", the communicator will not dial the number.

#### Priority Zone (Required for all zones in U.L. installations.)

A zone that will prevent arming if in trouble. If an attempt is made to arm, the sounder will come on and a [PRIORITY TROUBLE] will be displayed. The RP2600 keypad may be reset by simply pressing the [ON/OFF] Button. The problem on a Priority Zone must be corrected before the panel can be armed.

Any zone may be selected as a Priority Zone. A zone in trouble that is neither a Priority Zone nor an Auto-Bypass Zone will cause an alarm on arming.

Priority Zone with Bypass

A Priority Zone that will permit arming if the priority condition is bypassed. If the system is so programmed, the zone will auto-bypass, and (optional) the condition will be reported to a central station.

As above, if an attempt is made to arm, the sounder will come on and a [PRIORITY TROUBLE] will be displayed. To reset the keypad, enter an Arm/Disarm Code, or simply press the [ON/OFF] Button; the display will read [\*\*\*ZONE FAULT\*\*\*]. To arm the panel, press the [RESET] Button, then enter the Arm/Disarm Code.

Any zone not selected as a Priority Zone may be programmed as a Priority Zone with Bypass. If selecting Priority Zone with Bypass, Auto-Bypass is selected automatically. See Auto-Bypass; Closing Report Only on Force Arm.

Pulsing Sweep Output See Alarm Outputs

Receiver Format

The communicator can be programmed to transmit to any standard central-station receiver. A receiver format must be entered for each telephone number used, but a different format may be assigned to each.

Refer to Backup Reporting Telco 1, 2 and Report Telco 3 to determine whether or not Telephones 2 and/or 3 will be programmed. Call the central station for each telephone number used to confirm the type of receiver in use. Select the receiver format entry for each telephone number from the following table.

ENTRY	RECEIVER FORMAT	DATA FREQ.	DUTY CYCLE (ON/OFF)	INTERDIGIT TIME
(blank)	Ademco, Silent Knight "slow"	1900Hz	60/40mS	600mS
1	Sescoa, Vertex, DCI, Franklin	1800	30/20	800
2	Radionics "fast"	1850	13/12	400
3	Silent Knight "fast"	1900	40/30	560
4	Radionics, DCI, Franklin "slow"	1800	60/40	600
5	Universal Hi-Speed	1850	30/20	350
8	Radionics BFSK			

Relay 1 (Lug E12) (Not tested by U.L.)

Lug E12 (RELAY #1) will go to about 1Vdc when Relay 1 is tripped. This may be used to trip an LW-900 Long-Range Wireless Interface.

Or, a relay (400 ohms minimum) may be connected between Lug E12 and Terminal 12 (+ AUX. POWER) if a diode is inserted in series (cathode to E12; anode to relay coil).

Relay 2 (Lug E11) (Not tested by U.L.)

Lug E11 (RELAY #2) will go to about 1Vdc when Relay 2 is tripped. This may be used to trip an LW-900 Long-Range Wireless Interface. Or, a relay (400 ohms minimum) may be connected between Lug E11 and Terminal 12 (+ AUX. POWER) if a diode is inserted in series (cathode to E11; anode to relay coil).

Relay Outputs See Alarm Outputs

Report Service Code as User 15

The Service Code does not normally report. Select this feature to report Service-Code openings/closings with User 15 Opening/Closing Codes.

Report Telco 1

Report Telco 3 (Double or Split Reporting)

Alarms, alarm restores, troubles and trouble restores may be selected individually for each zone. Violation of a zone selected to report will communicate the code(s) selected for that zone to the central station.

Normally, Report Telco 1 is used to report to the central station. Report Telco 3 is used when certain zones will report to a different receiver (split reporting); Report Telco 1 and Report Telco 3 are both used on the same zone to report to two receivers successively (double reporting). Also see Backup Reporting Telco 1, 2.

Report Test Timer on Zone 16 See Test Timer

Reset Day Zone With Arm/Disarm Only See Day Zone

Reset Test Timer on Any Report See Test Timer

Selective Bypass

Removal of one particular zone from the system. Any or all Zones 1-64 programmed for selective bypass may be removed from the system, but each must be removed separately.

Selective bypassing is accomplished by pressing the [BYPASS ZONE] Button followed by the zone, which is entered as a two-digit number (e.g. "02" for Zone 2; "13" for Zone 13, etc.). The next time the panel is disarmed, all bypassed zones will automa-

tically revert to non-bypassed zones.

When one or more zones is bypassed, the yellow ZONE BYPASSED LED on the RP2600 keypad will light. The zones bypassed may be reviewed by pressing the [DISPLAY] Button, then the BYPASSED Button (Key [3]) with the RP2600 cover lowered.

Single-Digit Format See Data Format

Smoke Detectors See Fire Zones; Alarm Outputs

Split Reporting See Report Telco 3

#### Start Exit Delay After Ringback

When a closing report is successfully received, the central station will acknowledge by returning a *kissoff* signal. When the *kissoff* is received by the communicator, a 2-second *ringback* tone will sound at the panel. Start Exit Delay After Ringback will cause the exit delay to start *after* the ringback sounds.

If this option is chosen and no ringback sounds shortly after the control panel is armed, exit delay will not start and opening the exit/entry door will cause an alarm. To manually start the exit delay, select Function 7 (Start Exit Delay Without Ringback): press the FUNCTION Button, then Key [7], then exit the premises.

NOTE: (1) If this feature is selected, Exit/Entry Follower Zones will not arm until either a ringback sounds or Start Exit Delay Without Ringback (Function 7) is used. (2) If communicator, telephone lines or central-station receiver is out of service, the system will be armed without communication capability.

Status Report See Closing Report

Steady Lug (Lug E9) (Not tested by U.L.)

Lug E9 (STEADY) will go to about 1Vdc when the steady siren is tripped. E9 may be used to trip an LW-900 Long-Range Wireless Interface. Or, a relay (400 ohms minimum) may be connected between E9 and Terminal 12 (+ AUX. POWER) if a diode is inserted in series (cathode to E9; anode to relay coil).

#### Subscriber Identification Numbers

If reporting Openings/Closings, program Open/Close Subscriber Identification Numbers for each telephone number used. Program the Subscriber I.D. Number for each Bank and for each telephone number used. Start with the left-most position. Each bank must be programmed, even if all are identical.

Sum Check See Data Format

Sweep Lug (Lug E10) (Not tested by U.L.)

Lug E10 (SWEEP) will go to about 1Vdc when the sweep siren is tripped. E10 may be used to trip an LW-900 Long-Range Wireless Interface. Or, a relay (400 ohms minimum) may be connected between E10 and Terminal 12 (+ AUX. POWER) if a diode is inserted in series (cathode to E10; anode to relay).

Sweep Siren See Alarm Outputs

Swinger Shutdown (Do not program for U.L. Installations.)

Normally, Zones with Auto-Reset will only reset twice (3 alarms) until rearmed in order to prevent "swingers" (intermittents) from causing repeated false alarms, See Auto-Reset. The Swinger-Shutdown feature is programmable by zone, but is not applicable to the Ambush, Panic or Fire Zones.

#### Telephone Numbers

To report to a central station, Telephone Number 1 *must* be programmed. Telephone Number 2 is programmed for Backup Reporting; Telephone Number 3 is programmed for Double or Split Reporting.

Telephone Number 1 will be preceded by at least one Dial-Tone Detection entry "E" or Pre-Dial Delay entry "D" to ensure that the communicator detects a dial tone or waits a reasonable time to access a telephone line before dialing. (See Dial-Tone Detection; Pre-Dial Delay.) Furthermore, private telephone systems may require a separate Dial-Tone Detection or Pre-Dial Delay digit, followed by an Access Number to obtain an outside line. (See Access Number for Outside Line.)

It should be noted here that the telephone number will not actually start in the first location shown, and may not end in the last. Extra locations have been provided to allow for one or more prefix digits: a Pre-Dial Delay "D" or a Dial-Tone Detection "E". What is important is that the telephone number, with its associated Pre-Dial Delay, Access Number, and Dial-Tone Detection, be wholly contained within that group of locations, and that they be in their proper sequence.

NOTE: If the telephone number is not preceded by a "D" or an "E", the communicator will not dial the number.

#### Test Timer

Report Test Timer on Zone 16

Reset Test Timer on Any Report

If Report Test Timer on Zone 16 is programmed, an automatic test report will be transmitted to the central station, at a regular

interval (see Test-Timer Report Interval), from the time (a) the control panel is powered up; (b) the Control-Panel Reset Button is pressed (see Control-Panel Reset; or (c) the Dealer Program Mode is exited, unless programmed otherwise (see Test-Timer Offset Time). The respective Alarm Code is programmed as for Zone 16. If Test Timer is selected, the input to Zone 16 may still be used as a non-reporting zone (Zone 16 will not communicate if Test Timer is selected).

To report test timer, select Report Test Timer on Zone 16, enter Test-Timer Report Interval, and select Zone 16 to report on alarm for Telco 1 and/or Telco 3.

#### Test-Timer Offset Time

If the test timer is programmed, it will report immediately upon (a) power-up; (b) control-panel reset (see Control-Panel Reset); or (c) exiting the Dealer Program Mode, and at regular intervals thereafter. To delay the initial timer report from power-up time (timer offset), see Time Selection. (If these locations are left blank, the test timer will report immediately upon power-up, panel reset, or Dealer Program Mode exit.)

#### Test-Timer Report Interval

The Report Interval establishes the period, in days, between test transmissions. Address 457 must be programmed with at least a "1" for a 24-hour (1-day) report interval. Also see Time Selection.

#### Time-Out

Specifies the length of time that an alarm, alert, or delay will remain active. Relay Output 2 Access Control Time, Abort-Delay Time, and Chime Time must be programmed, or the feature will not activate. See Time Selection.

#### Time Selection Also see Programming Sheet

The following times are programmable:



Time (See Note 1)	Units	Max. Programmable Time
Relay Output 1 Time	minutes	Untimed (See Note 2)
Relay Output 2 Time	minutes	Untimed (See Note 2)
Relay Output 2 Access Control Time	seconds	4 min, 15 sec (255 sec)
Sweep Siren Time	minutes	Untimed (See Note 2)
Pulse-Sweep Siren Time	minutes	Untimed (See Note 2)
Steady Siren Time	minutes	Untimed (See Note 2)
Abort Delay (See Note 3)	seconds	4 min, 15 sec (255 sec)
Chime Time	seconds	See Note 3
Ac-Fail Report Delay	minutes	4 hr, 15 min (255 min)
Exit Delay (see Note 4)	seconds	4 min, 15 sec (255 sec)
Entry Delay 1 (see Note 4)	seconds	4 min, 15 sec (255 sec)
Entry Delay 2 (see Note 4)	seconds	4 min, 15 sec (255 sec)
Timer Offset	hours	24 hr (See Note 5)
Timer Report Interval	days	255 days (See Note 6)
Sensor-Match Time	24 hours	255 days (See Note 7)

**NOTES:**

1. The output used for Burglary must be at least 4 minutes in Residential U.L. installations, 15 minutes in Commercial U.L. installations.
2. If both locations are left blank, this feature will remain active until the system is disarmed. When both locations are programmed "F", maximum time will be 4 hours, 15 minutes (255 minutes).
3. If both locations are left blank, this feature will not activate (time-out = 0).
4. In U.L. installations: Maximum Exit Delay = 60 sec; Maximum Entry Delay = 45 sec.
5. If left blank and *Test Timer* selected, will report immediately on power-up.
6. Must be programmed for at least 1 day.
7. Time in units of 24 *disarmed* hours (accumulated between armed periods).

Any time-out up to those shown in the foregoing table may be programmed. Note that each of the above times is programmed in two locations. The first location has an assigned time factor of 16, the second a time factor of 1.

1st BOX	2nd BOX
tx16	tx1

Time (t):	0	1	2	3	4	5	6	7	8	9	10	11	12	13	14	15
Entry:	*	1	2	3	4	5	6	7	8	9	0	B	C	D	E	F

\*Blank.

NOTE: If *both* programming locations are left blank, refer to the notes in the foregoing table for feature time-out.

To select a time up to 15 seconds, 15 minutes, 15 hours, or 15 days, program the respective entry into the second box only, do not program the first box. To select a time greater than 15 seconds, 15 minutes, 15 hours or 15 days, program both boxes as follows:

1. For the feature selected, choose an appropriate time in units shown (all seconds, minutes, hours, or days -- not minutes and seconds, etc.).

2. Divide the time chosen by 16. Enter the *quotient* in the 1st BOX and the *remainder* in the 2nd BOX.
3. Check entries by adding the contents of the 2nd BOX to 16 times the contents of the 1st BOX. (Remember that a "zero" entry represents 10.)

**Example** Program Entry Delay 1 for 1-1/2 minutes.

1. Entry Delay 1 is in units of seconds, thus delay time is 90 seconds.
2. Divide by 16:  $90/16 = 5$  (quotient) + 10 (remainder). Enter the quotient in the 1st BOX and the remainder in the 2nd BOX:

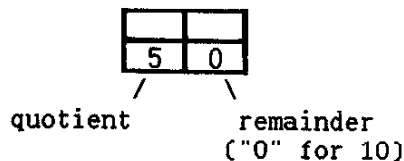

3. Check entries (remember, a "0" entry = 10):  $(16 \times 5) + 10 = 90$ .

TouchTone Dialing Only  
TouchTone With Rotary Backup

Select TouchTone Dialing Only if the subscriber has TouchTone service. TouchTone dialing is faster than rotary dialing, but not always as reliable.

For the communicator to use TouchTone on all dial attempts, program TouchTone Dialing Only. To use TouchTone on the first attempt with subsequent Rotary dial, program TouchTone With Rotary Backup. TouchTone Dialing Only will override TouchTone With Rotary Backup if both are selected. Note that if Backup Reporting is also selected, the communicator will use Rotary dial to reach Telephone 2. See Backup Reporting Telco 1, 2.

Trouble

An abnormal zone condition (a break in a normally-closed loop; a short on a normally-open loop; or either on an end-of-line-resistor supervised loop) when disarmed.

Trouble on a Burglary Zone is indicated as [**\*\*ZONE FAULT\*\***] on the display; the keypad will beep upon arming (does not apply to selective- or group-bypassed zones). If auto-bypass has been removed from a Burglary Zone, that zone will go into alarm on arming. If the zone is Exit/Entry, it will go into alarm after exit-delay and entry-delay times have elapsed (if the zone is still open at that time).

Trouble (open and/or short circuit) on a Day Zone is indicated by

a flashing green STATUS LED and a pulsing sounder; display the Day Zone(s) in trouble on the LCD. Keypad indications are reset by the [RESET] Button unless Reset Day Zone With Arm/Disarm is selected.

Trouble on a Fire Zone will be indicated on the bottom red FIRE/TROUBLE LED and the sounder. An open circuit (trouble) will cause a flashing LED and a pulsing sounder after a 15-second delay. (A short circuit will cause an alarm condition: steady-on LED and pulsing sounder.) The [RESET] Button will silence the sounder. Clear the trouble, then press the [RESET] Button once again. The keypad will reset after a brief delay.

#### Trouble On Open

#### Trouble On Short

Trouble On Night Open (Do not program for UL installations)

Trouble On Open will identify an open circuit on a loop as a trouble. Trouble On Short will identify a short circuit as a trouble. Trouble On Night Open, which will identify an open circuit on a normally-closed zone *while armed* as a trouble condition (not an alarm), is intended for use with a Napco Monitor-Series Double-Tech sensor. Any of these trouble conditions can be communicated if Report Trouble is programmed as well. See PIR Supervision.

Two-Digit Format See Data Format

#### User Program Code

This code is required to enter the User Program Mode, permitting an authorized user to program codes, exit/entry times and zone descriptions (see Section 5). Enter the 4- to 6-digit User Program Code starting in the left-most location.

Watch On With Function 2 See Day Zone

#### 24-Hour Protection

A zone that provides protection at all times, whether or not the system is armed. Neither the green STATUS nor the red SYSTEM ON/INTRUSION LED will indicate the condition of a zone programmed for 24-Hour Protection, however an alarm condition will be recorded by Alarm History after the [RESET] Button is pressed or the panel is armed, then disarmed.

NOTE: Do not program 24-Hour Protection on a Day Zone.

**FOR SALES, SERVICE, OR TECHNICAL ASSISTANCE, CALL TOLL FREE:**

**(800) 645-9445**

## 5. GETTING UP AND RUNNING

This section will focus on starting and using the RP2600 keypad after installation is completed. References are made to keypad programming, which is covered in detail in PROGRAMMING (Section 3). If there is more than one keypad in the system, only the main one can be used for programming.

### PRELIMINARY INFORMATION

Carefully read and note the following before proceeding:

1. Throughout this text, panel markings will be shown in upper-case letters (e.g., SAVE Button); button markings and LCD displays will be shown in bracketed upper-case letters (e.g., [ON/OFF] Button, [\*SYSTEM READY\* ]).
2. The default Arm/Disarm Code is 7,8,9. For security reasons, this code must be changed before the system is put into active service. Refer to Arm/Disarm Codes.
3. The default User Program Code is 1,2,3,4,5,6. For security reasons, this code must be changed before the system is put into active service. Refer to Program Code.
4. When entering or programming codes or locations, follow the numeric entry by the [ON/OFF] (SAVE) Button. The command will not be acknowledged, nor the program entered, until this button is pressed.
5. If the RP2600 cover is left raised and the keypad unused for longer than 4 minutes, a steady tone will sound as a reminder that the cover should be lowered. Silence the sounder by pressing any button (except the emergency buttons at the bottom), or by lowering the keypad cover, which will terminate the Program Mode.

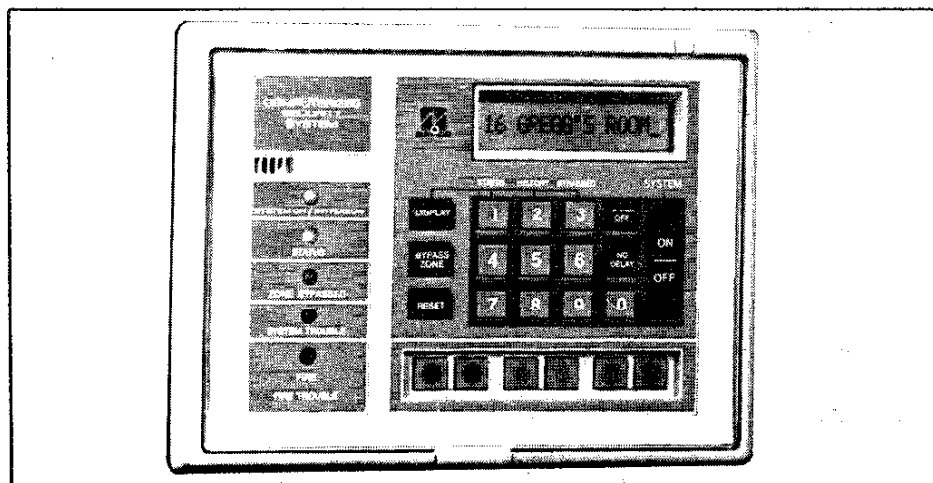

RP2600 Keypad.

## POWER-UP SEQUENCE & INITIAL CHECKOUT

1. Complete system wiring. Refer to the Wiring Diagram.
2. Remove and discard the paper insulator under the lithium battery clip. Check the lithium battery; it should measure more than 2.75Vdc.
3. With the keypad cover lowered, connect ac power. (If Power Up In Last State has been programmed and the panel comes up armed, simply press [7], [8], [9], [ON/OFF] to disarm.)
4. Install battery:
  - only the green STATUS LED should light;
  - the display should read [\*SYSTEM READY\* ].
5. Raise the RP2600 cover and hold down the TEST Button (just below the [0] Key):
  - check that all LEDs light;
  - check that the keypad sounds a continuous tone;
  - check that the numeric display goes black.Release the TEST Button.  
NOTE: The above test may have been programmed to perform a telephone-line check if the system is connected for central-station reporting. If the system does not see a dial tone on the phone line, the display will read [FAIL, HIT RESET]. Press the [RESET] Button.
6. Adjust the VIEWING ANGLE control at the left for maximum LCD brightness and contrast. Lower the keypad cover.
7. Check default Arm/Disarm Code by pressing [7], [8], [9], [ON/OFF]:
  - red SYSTEM ON/INTRUSION LED will light;
  - the display will count down exit delay time until it reads [\*\*\*\*\*ARMED\*\*\*\*\* ]
8. Disarm system by again pressing [7], [8], [9], [ON/OFF]:
  - only the green STATUS LED will light;
  - the display will read [\*SYSTEM READY\* ].

## USER KEYPAD PROGRAMMING

NOTE: (1) Only the main keypad (RP2600 #1) may be used for programming (see INSTALLATION, Section 2); (2) The Program Mode cannot be accessed while the communicator is transmitting.

In the Program 1 Mode, the user can customize codes, exit/entry times and zone descriptions in the following sequence.

- |                  |               |                         |
|------------------|---------------|-------------------------|
| • User Code 1-16 | • Access Code | • Entry Time 1          |
| • Service Code   | • Ambush Code | • Entry Time 2          |
| • Program Code   | • Exit Time   | • Zone Description 1-64 |

1. Raise the keypad cover. Enter the system Program Code (default code 1,2,3,4,5,6) then press the [ON/OFF] Button to access the Program 1 Mode. (Also see Program Code.) The LCD will briefly read [ PROGRAM1 #XXXX], and then [USER 01 (789 )].
2. With the keypad cover raised, the numeric keys no longer perform as expected: Keys [1] and [2] position the cursor left and right respectively within the display; Keys [4] and [7] scroll up and down respectively through numbers 0-9, the alphabet, etc. (depending on what is being programmed) as shown on the display.
3. The following buttons also take on new meanings in the Program 1 Mode:
  - [NO DELAY] (NEXT) scrolls the display forward to the next line (hold down for fast forward).
  - [INTERIOR OFF] (PRIOR) scrolls the display backward to the previous line (hold down for fast reverse).
  - [ON/OFF] (SAVE) memorizes the programmed code, description, etc.
4. Closing the cover terminates the Program 1 Mode.

Arm/Disarm Codes. Up to 16 personal user codes may be programmed at the keypad.

Refer to **USER KEYPAD PROGRAMMING**. The first code entered should replace the default code (7,8,9), which may not be selected as a user code. Enter up to six digits; a minimum of four digits is recommended. After the code has been entered, press the SAVE Button ([ON/OFF]).

**NOTE:** Do not attempt to enter any blank spaces in the code. The keypad will reject a code with a blank space and respond with a steady tone and a flashing blank space in the display. Silence the tone by pressing any button (except the emergency buttons at the bottom), then enter any digit, even 0, into the blank space to complete the code.

Press the NEXT Button ([NO DELAY]) once to advance to the next user code and repeat the above for the second user code. Advance to the next user code and repeat until all user codes have been programmed. Close the cover when finished.

Each user should be assigned his own dissimilar code and should be cautioned against divulging his code to anyone else. Thus should it become necessary to remove a user from the system, that one code may be cancelled without affecting other codes, and that user would then be prevented from entry.

**Changing or Cancelling a Code.** To change any code, merely pro-

gram over the existing code as previously described, then press the SAVE Button [ON/OFF]. Similarly, to cancel a code, blank out each number of the code using the BLANK Button [5], then press the SAVE Button [ON/OFF].

**Service Code.** The Service Code is a temporary Arm/Disarm Code, and is programmed as any other user code. See Arm/Disarm Codes; Function 3: SERVICE CODE.

**Program Code.** The Program Code provides access to the Program Mode. The user authorized to program should have the Program Code committed to memory or recorded and safeguarded elsewhere, and should be cautioned not to divulge that code to anyone.

Raise the RP2600 cover and enter the default Program Code (1,2,3,4,5,6) to access the Program Mode. Hold down the NEXT Button [NO DELAY] to scroll the display to the Program Code. The Program Code *must be changed* in order to maintain system security. Program the Program Code as you would any Arm/Disarm Code (see USER KEYPAD PROGRAMMING).

**Access Code.** The Access Code is normally used to activate a door striker while disarmed to remotely unlock a door. (See Access Control on Relay 2 in the glossary for programming required to enable this feature.) Program the Access Code as you would any Arm/Disarm Code (see USER KEYPAD PROGRAMMING). *Caution:* Do not use the same code as any Arm/Disarm Code.

**Ambush Code.** The Ambush Code is entered by the user just prior to disarming to access the Ambush Zone, causing a silent report to be sent to the central station. Thus, should the user be forced to disarm by an assailant, he can silently signal an emergency while appearing to be merely disarming the panel. (Check the glossary for programming required to enable this feature.) Program the Ambush Code as you would any Arm/Disarm Code (see USER KEYPAD PROGRAMMING).

**Exit/Entry Times.** Exit delay and entry delay establish the amount of time that is available on the Exit/Entry Zone after arming and before disarming, respectively, before the system will go into alarm. Two separate entry delays are available.

Exit and entry times are programmed just as user codes. Enter the Program Mode and scroll past all the codes until the RP2600 displays [EXIT TIME (\_ )]. Use all three digits to enter the exit time, in seconds, even if leading "0"s are necessary. Thus, to program 30 seconds, enter "030"; to program 2 minutes, enter "120", etc (Maximum programmable time is 255 seconds.)

Press the NEXT Button ([NO DELAY]) and repeat the above procedure to program ENTRY TIME 1. Press the NEXT Button once again and similarly program ENTRY TIME 2.

**Zone Descriptions.** Zone descriptions follow exit/entry-times in the normal programming sequence ("01" will appear in the display,

followed by the cursor). Refer to **USER KEYPAD PROGRAMMING**. Program the description letter by letter. With the keypad cover up, Keys [1] and [2] control the position of the cursor. When programming zone descriptions, Keys [4] and [7] will scroll not only through numbers 0-9, but through the alphabet and a series of punctuation marks and symbols as well. Roughly note the order in which the letters, numbers and symbols are displayed so that you will be able to determine the proper direction to scroll (up or down) for fastest access. As familiarity improves, so will programming speed. When the description has been entered and is satisfactory as displayed (e.g. [GARAGE]), press the SAVE Button [ON/OFF] to save it in memory.

Use the NEXT Button [NO DELAY] to advance to the next zone description. To return to the previous description, press the PRIOR Button [INTERIOR OFF]. Similarly, enter zone descriptions for all zones in use (up to 64) using the foregoing programming procedure.

The following words and phrases related to the home and office are stored in a description library. To help speed the programming process, any of these may be entered as a complete unit, thus eliminating or reducing the letter-by-letter programming required for that description.

ZONE NOT USED	BEDROOM	FRONT DOOR	LIVING ROOM
BURGLARY ZONE	COMPUTER ROOM	GARAGE	OFFICE
BASEMENT	DINING ROOM	HALL	STOCKROOM
BATHROOM	FAMILY ROOM	KITCHEN	STUDY

To choose from the list, you must be in the Zone-Description Program Mode. Press the WORDS Button (Key [8]) repeatedly until the desired word or phrase is displayed (e.g. [01 \_ DEPT]), then customize the description if necessary using the manual letter-by-letter method previously described. When the description is satisfactory as displayed (e.g. [01 SALES\_ DEPT]), press the SAVE Button [ON/OFF] to save it in memory.

To simultaneously clear all zone-description messages for Zones 1 through any other zone number (inclusive), enter the Zone-Description Program Mode. At the "01" display, enter "CMXX", where XX represents any zone from 1 to 64, then press the [ON/OFF] Button. Note that the zone number must be expressed as a two-digit number, thus Zone 8 is entered as "08". Then, to clear descriptions for Zones 1-8, at the "01" display, enter "CM08", then press the [ON/OFF] Button.

#### **ARMING & DISARMING THE SYSTEM**

**NOTE:** In the normal disarmed state, only the green STATUS LED will be on and the display will read [**\*SYSTEM READY\***]. To silence an alarm, enter any Arm/Disarm Code, then press the [ON/OFF] Button.



Any of the user codes or the Service Code (when active, see Function 3. SERVICE CODE) may be used to arm or disarm.

**Arming.** To arm, enter the code using the numeric keys, then press the [ON/OFF] Button. The display will read [ PLEASE WAIT ] while the control panel communicates to the central station. After the central station acknowledges receipt, a "ringback" tone will sound at the keypad. The green STATUS LED will go off, the red SYSTEM ON/INTRUSION LED will go on, and the display will read [EXIT TIME XXX ] ("XXX" representing the programmed exit-delay time, in seconds). The exit delay will immediately start counting down toward "000", indicating the available time remaining to exit through an exit/entry door.

**NOTE:**

1. If exit delay was programmed to start after ringback, and the ringback tone does not sound within about 30 seconds, Function 7 may be used to manually start exit delay. See SPECIAL FUNCTIONS.
2. If the control panel does not report to a central station, exit delay will start as soon as Arm Code is entered.
3. An "S" in the display (e.g. [EXIT TIME XXX S]) will appear as a reminder that the system is being armed with the Service Code active. (To turn off the Service Code, disarm using a regular Arm/Disarm Code.)
4. If the SYSTEM TROUBLE LED is on and the display reads [ CHECK TROUBLE ], check and correct the system trouble (see THE DISPLAY BUTTON). After the trouble is checked, it will be possible to arm within 5 minutes if repairs cannot be made immediately.

**Disarming.** When the exit time has elapsed, the display will read [\*\*\*\*\*ARMED\*\*\*\*\* ]. This indicates that upon entering the premises through an exit/entry door, there will be an entry delay to allow time to disarm the panel. The RP2600 display will read [ENTRY TIME XXX ] ("XXX" representing the programmed entry-delay time, in seconds). The entry delay will immediately start counting down toward "000", indicating the available time remaining to disarm the panel. To disarm the panel, enter the code using the numeric keys, then press the [ON/OFF] Button.

**Arming with No Delay.** To cancel the entry delay on the exit/entry zone, press the [NO DELAY] Button prior to or after arming. The display will read [\*\*\*\*\*ARMED\*\*\*\*\* I]. This feature may be used to provide instant protection while on the premises. It will be cancelled automatically upon disarming.

**Priority Arming.** A steady tone and [PRIORITY TROUBLE] displayed when attempting to arm indicates a priority condition; that is, a problem exists on at least one zone that has been designated a Priority Zone. Enter an Arm/Disarm Code, or simply press the [ON/OFF] Button to silence the sounder.

The trouble(s) must be corrected before the panel can be armed. To check which zone is in trouble, lower the keypad cover and

press the [DISPLAY] Button, then the STATUS Button (Key [1]). The display will read [ ZONES FAULTED ], then scroll through all the problem zones.

### BYPASSING ZONES

Those zones designated as *selective bypass* zones may be bypassed from the system prior to arming. With the RP2600 cover down, press the [BYPASS ZONE] Button, then the numeric key representing the zone number. The yellow ZONE BYPASSED LED will go on and the zone number will appear briefly on the display. Repeat for each zone to be bypassed. To recall which zones have been deactivated, press the [DISPLAY] Button, then the BYPASSED Button (Key [3]).

When the panel is disarmed, all bypassed zones revert to normal disarmed zones. Therefore, to cancel a bypassed zone, arm and disarm (which will cancel *all* bypassed zones simultaneously).

**Interior Zones.** All zones that have been designated as group-bypass zones will be bypassed at the same time when the [INTERIOR OFF] Button is pressed prior to arming. This feature is used to provide perimeter protection while keeping active interior zones disarmed. As above, the [DISPLAY] and BYPASSED Buttons may be used to display zones bypassed.

### ALARM INDICATION

**NOTE:** To silence an alarm, enter the Arm/Disarm Code, then press the [ON/OFF] Button.

Should an alarm occur, the top red SYSTEM ON/INTRUSION LED will flash, and the display will read [ ALARM ], then scroll through all the zones violated. Disarm the panel; the display will read [ ALARM MEMORY ] and will continue to indicate the violated zones until the [RESET] Button is pressed or the panel is armed once again. The alarm conditions will then be stored in Alarm History (see Alarm History).

### THE DISPLAY BUTTON (RP2600)

*With the keypad cover lowered,* the [DISPLAY] Button will provide a visual indication of the following conditions on the readout:

- **Zones in Fault ("Trouble") Condition.** Press the [DISPLAY] Button followed by the STATUS Button (Key [1]) to identify the zones in trouble (while disarmed). No manually bypassed zones will be indicated when displaying status.
- **Directory.** To scroll through a list of all programmed zone descriptions, press the [DISPLAY] Button, then the DIRECTORY Button (Key [2]). To return to the system, press the [RESET] Button at any time.

- **Zones Bypassed.** Press the [DISPLAY] Button then the BYPASSED Button (Key [3]) to list zones that have been deactivated.

*With the keypad cover raised, the [DISPLAY] Button will provide a visual indication of the following conditions:*

- **Fire Status.** To display the condition of the Fire Zones (if installed) press the [DISPLAY] Button, then the FIRE STATUS Button (Key [1]).
- **System Troubles.** Pressing the [DISPLAY] Button followed by the SYSTEM TROUBLE Button (Key [2]) will display system problems (LOW BATTERY, AC POWER LOSS, etc.).
- **Alarm History.** Alarm conditions occurring during the last four arm/disarm intervals are retained in memory. Alarm History #1 always contains the most recent interval, Alarm History #2 the next, etc. Press the [DISPLAY] Button, then the ALARM HISTORY Button (Key [3]).

## SPECIAL FUNCTIONS

To access Functions 1 through 8, first raise the keypad cover, press the FUNCTION Button ([BYPASS ZONE]), then the respective function number key.

**Function 1: BELL TEST.** This test will activate the speaker/bell output (while disarmed) for about 2 seconds. To test the device, press the FUNCTION Button ([BYPASS ZONE]), then Key [1]. If the device does not sound, it may be defective.

**Function 2: WATCH MODE.** This option, if programmed, permits all zones designated as Day Zones to be turned on. To activate the Watch Mode (Day Zones on), press the FUNCTION Button ([BYPASS ZONE]), followed by Key [2]; a "W" will appear in the display as long as the Watch Mode is active. To deactivate the Watch Mode, arm, then disarm.

**Function 3: SERVICE CODE.** The Service Code is an Arm/Disarm Code that is easily activated when needed, and dormant at other times. It is intended for the occasional or temporary user (maid, repairman, etc.) who would otherwise be denied access to the premises. The Service Code is activated by enabling Function 3, press the FUNCTION Button ([BYPASS ZONE]), then Key [3]. When the panel is armed (using any Arm/Disarm Code) with Function 3 accessed, an "S" will appear in the display along with the exit-delay countdown, indicating that the Service Code is active. The Service Code will automatically become inactive the next time a regular Arm/Disarm Code is used to *disarm* the system, and it will remain so until Function 3 is selected once again.

**Function 4: CHIME MODE.** This option will sound a tone at the keypad when a zone programmed as Chime Zone is violated while

disarmed. The duration of the tone is programmable. To activate Function 4, press the FUNCTION Button ([BYPASS ZONE]) followed by Key [4]; a "C" will appear in the display as long as the Chime Mode is active. Repeat to deactivate Function 4, thus turning off the Chime Mode.

**Function 5: LOCATE.** This feature will help the user find zone troubles and indicate when they are repaired. To access Function 5, press the FUNCTION Button ([BYPASS ZONE]), then Key [5]. The sounder will come on and the display will read [ LOCATE ], then scroll through the zones in trouble. As each zone is corrected, the sounder will stop momentarily signalling its repair, and the display will indicate the remaining zones in trouble. The sounder and display will continue in this manner until all zones are repaired, or until the [RESET] Button is pressed.

**Function 6: FAULT FIND.** This troubleshooting aid will help the installer locate swingers. To access the Fault-Find Mode, press the Function Button ([BYPASS ZONE]), then Key [6]. When accessed, two things occur:

- a. the loop response of each zone is set for the fastest response time, and
- b. Causing or repairing a fault activates the sounder for about 3 seconds.

Tapping and poking at suspect points, the installer can easily locate swingers by listening for the beep. This eliminates the need of returning to the keypad to visually check after each attempt. Press the [RESET] Button to restore normal operation. (Arming the system automatically cancels the Fault-Find Mode.)

**Function 7: START EXIT DELAY WITHOUT RINGBACK.** If the central station *ringback* signal has not been received within about 30 seconds, a communication problem may exist. To start exit delay manually, press the FUNCTION Button ([BYPASS ZONE]) then Key [7].

**Function 8: MANUAL DOWNLOAD.** Used on-site by the installer to download data from the central station. To initiate the data transfer, arm the panel, disarm, press the FUNCTION Button, then press Key [8]. (The installer must be in contact with the central station, as a different procedure is initiated at the head end.)

**Function 9: CLEAR ACTIVITY FAILURE.** Resets a PIR Supervision system trouble. See PIR Supervision.

**Control-Panel Reset.** This small switch (S1) is located at top center of the control-panel board near Fuse F5. Pressing S1 momentarily will initialize the panel as from power-up, however the program in memory will be retained. (If the lithium battery is exhausted or not installed, the default program will be loaded.) If Power Up In Last State was programmed and the system had been armed, the panel will come up armed (if no Priority Zones are in trouble).

## KEYPAD MESSAGES

The keypad can display the following messages. (Programming displays are described in **USER KEYPAD PROGRAMMING** earlier in this section, and **DEALER KEYPAD PROGRAMMING** in Section 3.)

*SYSTEM READY*CW	All zones operating; system can be armed. <i>C</i> denotes Chime Mode on; <i>W</i> denotes Watch Mode on.
PLEASE WAIT	Panel reporting to central station on arming. Wait for ringback signal to exit.
EXIT TIME XXX SI	Exit delay in progress. <i>XXX</i> denotes exit time remaining; <i>S</i> indicates Service Code active; <i>I</i> indicates arming with <i>Instant</i> protection.
ENTRY TIME XXX	Entry delay in progress. <i>XXX</i> denotes entry time remaining.
*****ARMED****SI	Panel armed. <i>S</i> and <i>I</i> indications as above.
**ZONE FAULT**CW	Trouble condition. Display Troubles for zone description(s). <i>C</i> and <i>W</i> indications as above.
PRIORITY TROUBLE	Arming attempted with Priority Zone in trouble. Press [ON/OFF]. Display Status. Correct trouble to arm.
DAY ZONE TROUBLE	Trouble condition on Day Zone, followed by one or more zone descriptions.
ZONES FAULTED	(When Status displayed) indicates zone(s) in fault condition.
CHECK TROUBLE	System trouble. After trouble is checked, panel system may be armed within 5 minutes.
ALARM	Alarm condition, followed by one or more zone descriptions.
FIRE TROUBLE	(When Fire Status displayed) trouble condition on Fire Zone. Press [RESET] to silence sounder. Correct trouble, then press [RESET] again.
FIRE ALARM	(When Fire Status displayed) alarm condition on a Fire Zone. Press [RESET] to silence sounder. Correct cause of alarm; press [RESET] again.
NORMAL	(When Fire Status displayed) Fire Zones normal.
ZONES BYPASSED	(When Zones Bypassed displayed) indicates zones that have been deactivated.
SYSTEM TROUBLE	(When System Troubles displayed) indicates system trouble(s) (below).
LOW BATTERY	If not recharged within 24 hours, replace.
AC POWER LOSS	Check power transformer. Check for blown fuse or circuit breaker; general power outage.
ACTIVITY FAILURE	No trip detected on PIR Supervision Zone within programmed Sensor-Watch time. To reset, press FUNCTION Button, then Key [9].
PROM IN SOCKET	For installer: Remove PROM (see PROM downloading instructions in WI411).
TELCO LINE FAIL	Failure of dial-tone test.
FAIL TO COMM	Unsuccessful communication to central station.
EZM FAILURE XX	Indicates failure of an expansion zone module. <i>XX</i> denotes module number.
TAMPER	(Followed by [ ZONE MODULE <i>XX</i> ].) EZM module cover removed. <i>XX</i> denotes module number.
KEYPAD FAILURE X	A keypad is defective. <i>X</i> denotes keypad number.

**XX OUT OF SYSTEM** Keypad inoperative; call for service.  
**CALL SERVICE E1** Control-panel program fault. Entering Dealer Program Mode clears system trouble but problem must be fixed. If Quickloader available, reload program, otherwise (a) press panel reset micro-switch; (b) enter Master Security Code to enter Dealer Program Mode; (c) access Location 997 (Clear Dealer Program) then press [ON/OFF] button; (d) reload program.  
**ALARM HISTORY #1** Displays alarm conditions of last arm/disarm interval. Similarly, Alarm History #2, #3, and #4 display prior arm/disarm intervals.  
**TESTING** (After TEST Button released) test in progress.  
**FAIL, HIT RESET** Dial-tone test failed; press RESET Button.  
**FAULT FIND** Fault-Find Mode activated.  
**LOCATE** Locate Mode activated.  
**\*\*\*\*\*** Downloaded keypad message.

### CHANGES FROM PREVIOUS EDITION

Following is a summary of revisions since the last edition.

Page 1: TABLE OF CONTENTS revised.  
 Page 2: Magnum Alert 2600LKDLM, note added at end.  
 Page 3: RP2600 Keypad Features, reference to "medical" emergency deleted.  
 Page 4: SPECIFICATIONS, "TRF9" changed to "TRF11"; note added at bottom.  
 Page 5: Equipment Supplied, "TRF9" changed to "TRF11".  
 Optional Accessories and Peripherals updated,  
 ● EOL2.2K added ● TRF12 amended  
 ● LW5R added ● WL1 added  
 ● TRF9 deleted ● RP2000LCD/RP2000LED note added.  
 COMPATIBLE UL-LISTED DEVICES, Ademco Bell part numbers corrected (AD8-12; AD10-12); Note amended at bottom.  
 Page 10: TYPICAL FIRE INSTALLATION. "Mercantile" note added.  
 Page 11: UL MERCANTILE INSTALLATION added.  
 Page 13: Dealer Keypad Programming, note added.  
 Page 28: Arm Lug, text revised to reference use with Napco Monitor-Series Double Tech sensors.  
 Page 30: Disable Callback Download, UL note added.  
 Disable Carrier Download, UL note added.  
 Page 35: Disable Function-8 Download, UL note added.  
 Easy Arm With On/Off Button, UL note added.  
 Page 36: Enable Green Keypad Buttons as Zone 15, reference to "medical" deleted.  
 Page 38: Fire Zones 1, 2, "Mercantile" note added.  
 Page 41: Loop Response, UL note added.  
 Low Battery, UL note added.  
 Page 51: Trouble On Night Open, UL note added.  
 Pages 65-67: INDEX revised.  
 Page 70: WIRING DIAGRAM, UL notes added.

## INDEX

Abort Delay	25	Bypass,		Disable Call Waiting	34-35
also see Time-Out	48	Button	58-59	Disable Callback Download,	
Time Selection	48-49	Display (Zones Bypassed)	59	see Callback-Method Download	30
Ac Failure		Group	31, 39, 58	Disable Carrier Download,	
Indication (System Trouble)	25, 59	IFD, (ZONES BYPASSED)	58	see Callback-Method Download	30
Reporting	25	Selective	31, 45-46, 58	Disable Function-8 Download	35
also see Time Selection	48-49	Zone-Select (BYPASS ZONE) Button	58	Disable Keypad Panic, see Jumpers	39
Access Control on Relay 2	25	Call Waiting,		Disable Smoke Reset on Relay 1	35
Access Number for Outside Line	25	see Disable Call Waiting	34-35	Disable Tactile Beep, see Jumpers	40
Accessories & Peripherals	5	Callback-Method Download	30	Disarming	57
Activate Zone 14 On EZM Tamper	26	Chime Mode (Function 4)	30, 40, 59-60	Display Button	58
Adding Expansion Zones	8-9	also see Time-Out	48	Double Reporting,	
Alarm History	26, 59	Time Selection	48-49	see Report Telco 3	45
also see Alarm Indication	58	Clear Activity Failure (Function 9)	60	also see Telephone Numbers	47
24-Hour Protection	51	also see PIR Supervision	42	Downloading	14
Alarm Indication	58	Clear Dealer Program, see Keypad		Downloading Messages	14
Alarm On Day Zone, see Day Zone	33	Messages: [CALL SERVICE E1]	62	"E" Lugs	35
Alarm Outputs	26	Clear Shutdown Message,		Easy Arm With On/Off Button	35
also see Time Selection	48-49	see Downloading Messages	14	Enable Blue Keypad Buttons as Panic	
Alarm Reset, see Alarm Indication	58	Closing Codes,		Zone, see Panic Zone	42
Alarm Time-Out, see Time-Out	48	see Closing Report	31, 42, 45	Enable Green Keypad Buttons Zone 15	36
Ambush Code	27, 53, 55	Closing Report	31, 42, 45, 46	Enable Red Keypad Buttons as Fire	
Ambush Zone	27-28, 47	Closing Report Only on Force Arm	31	Zone, see Fire Zones 1, 2	38
Anti-Jam Time	28	Codes		Enable Telco Test on Keypad Test	36
Arm Lug (E4)	28	Access	55	also see Load Default Program	40
Arm/Disarm Codes 12, 40, 52-56, 58, 59		Ambush	27, 55	Entry Delay	34, 37, 55, 57
Arming	56	Arm/Disarm 12, 40, 52-56, 58, 59		also see Time Selection	48-49
LED (SYSTEM ON/INTRUSION)	51, 53, 57, 58	Change or Cancellation	54-55	Equipment Supplied	5
Priority	57	Closing	31, 42, 45	Event Codes	36-37
With No Delay	57	Dealer Security	33-34	Exit Delay	34, 37, 55, 57
With System Trouble	57	Event	36-37	also see Time Selection	48-49
Auto Bell Test Upon Arming	28	Force Arm	31	Exit/Entry Follower	37-38
Auto-Bypass	28	Master Security	33-34	Expansion Zones	8-9, 38, 41
also see Closing Report Only		Opening	42	also see Number of EZM Groups	41
on Force Arm	31	Program	55	Extended Format, see Data Format	32
Priority Zone with Bypass	44	Programming	53-56	Fault Find (Function 6)	60
Trouble	50	Service	55, 57, 59	Features	3
Auto-Reset	29	User	53-57	Fire	
also see Swinger Shutdown	47	Data Format	32	Alarm	38, 51
Auto-Reset After Sweep Siren		Day Zone	33	Installation, Typical	10
Time-Out, see Auto Reset	29	also see Function 2: Watch Mode	59	LED (FIRE/FIRE TROUBLE)	38
also see Load Default Program	40	Trouble	50-51	Lug (E9), see Steady Lug	46
Backup Reporting Telco 1, 2	29	24-Hour Protection	51	Trouble	38, 51
also see Telephone Numbers	47	Dealer Keypad Programming	13	Zones	38
Bank	29, 32, 36, 46	Dealer Security Code	33-34	Force Arm	31
Battery	29, 40, 41, 43, 53	Default Program,		Glossary	15, 25-51
Bell, Grade-A, see Alarm Outputs	27	see Load Default Program	40	Grade-A Bell, see Alarm Outputs	27
Bell Test (Function 1)	56	Dial Delay, see Pre-Dial Delay	49	Ground-Start Module, CSA-100	
also see Auto Bell Test Upon		Dial-Tone Detection	34	(Lug E3)	38-38
Arming	28	also see Anti-Jam Time	28	Grounding	7
Bells, Recommended (U.L. Listed)	5	Pre-Dial Delay	43	Group Bypass	39
Burglary Lug (E10), see Sweep Lug	47	Telephone Numbers	47	also see Interior Zones	58
Burglary Output, see Alarm Outputs	26	Disable Auto-Reset On Day Zone,		Interior Normally Bypassed	39
		see Day Zone	33	Include Selective/Group Bypass	

In Force Arm/Status	31	Power-Up Sequence	53	Single-Digit Event Code Format,	
Initial Checkout	53	Pre-Dial Delay	43	see Data Format	32
Installation	6-11	also see Access Number for		Smoke Detectors, see Fire Zones	38
Instant Protection, see		Outside Line	25	Recommended (UL Listed)	5
Arming with No Delay	57	Dial-Tone Detection	34	Reset, see Alarm Outputs	26
also see Exit/Entry Follower	37-38	Telephone Numbers	47	also see Disable Smoke Reset on	
Interior Normally Bypassed	39	Priority Zone	43, 57, 60	Relay 1	35
Interior Zones	58	Priority Zone with Bypass	44	Speaker/Bell Output,	
Jumpers	39-40	also see Ac Failure	25	see Alarm Outputs	26
also see Alarm Outputs	26	Auto-Bypass	28	Speakers, Recommended (U.L. Listed)	5
RP2600 Keypad Assignment	8	Programming	12-24	Specifications	4
Keypad (RP2600)		Downloading	14	Split Reporting	
Assignment	8	Keypad	12-13	see Report Telco 3	45
Controls & Indicators	52-62	Dealer	13	Start Exit Delay After Ringback	46
Features	3	Record Sheets	13, 19-24	Start Exit Delay Without Ringback	
		User	53-56	(Function 7)	60
		PROA	12, 14-15	Status	
Jumpers	8, 39-40	Record Sheets	12, 16-18	Display	
Messages	61-62	Transferring Memory From	12	FIRE STATUS Button	59
Mounting	6	Steps	14	STATUS Button	58
Operation	52-62	PROA		LED (STATUS)	51, 53, 56-57
Panic, see Panic Zone	42	Load PROA	12, 41	Report, see Closing Report	31
Programming	12-13	Programming	12, 14-15	Steady Lug (E9)	46
Dealer	13	Programming Record Sheets	12, 16-18	Subscriber ID Numbers	14-15, 46
User	53-56	Transferring Memory From	12	also see Backup Reporting	29
Special Functions	59-60	Pulsing Sweep Output,		Closing Report	31
Line-Reversal Module, M278	40	see Alarm Outputs	26	Data Format	32
Listen-In Module (Lug E5)	40	Receiver Format	44	Opening Report	42
Load Default Program	40	Relay 1 (Lug E12)	44-45	Sum-Check Format, see Data Format	32
Load PROA	41	Relay 2 (Lug E11)	45	Sweep Lug (E10)	47
Locate (Function 5)	60	Relay Outputs, see Alarm Outputs	26	Swinger Shutdown	47
Loop Response	41	also see Time Selection	48-49	System Trouble	7, 12, 25, 36
also see Function 6: Fault Find	60	Reset Day Zone With Arm/Disarm Only	33	Display	59
Low Battery	41	Report Service Code as User 15	45	LED (SYSTEM TROUBLE)	25, 57
Manual Download (Function 8)	60	Report Telco 1, 3	45	Tamper Switches	7
Master Security Code, see		Report Test Timer on Zone 16	47-48	also see Activate Zone 14 on	
Dealer Security Code	32-33	Reset		EZA Tamper	26
Mounting	6	Control-Panel Microswitch	43, 60	Wiring to a Grade-A Bell	27
No EOL Resistor	41	Keypad Button	25, 33, 35, 36, 38,	Telephone Numbers	47
Number of EZA Groups	41	44, 51, 53, 58, 60		also see Access Number for	
Number of Keypads,		Reset, Alarm	58	Outside Line	25
see Keypad Assignment	8	Reset Test Timer on Any Report	47-48	Closing Report	31
Number of Rings Before Callback,		Restore Codes, see Event Codes	36-37	Data Format	32
see Callback-Method Download	30	Ringback, see Arming	57	Dial-Tone Detection	34
Opening Codes, see Opening Report	42	also see Start Exit Delay After		Disable Call Waiting	34-35
Opening Report	42, 45, 46	Ringback	46	Pre-Dial Delay	40
Opening Report Only After Alarm	42	Start Exit Delay Without		Receiver Format	44
Optional Accessories & Peripherals	5	Ringback (Function 7)	60	Test	
Ordering Information	5	Selective Bypass	45-46, 58	Bell (Function 1)	59
Outputs, see Alarm Outputs	26-27	also see Include Selective/Group		also see Auto Bell Test Upon	
Panic Buttons	39, 42	Bypass In Force Arm/Status	31	Arming	28
Panic Zone	42, 47	Trouble	50	Keypad	53
PIR Supervision	42	Sensor Watch, see PIR Supervision	42	also see Enable Telco Test on	
Power Transformer Selection	9	also see Time Selection	48-49	Keypad Test	36
Power-Up Delay	43	Service Code (Function 3)	59	Test Timer	47
Power Up In Last State	43				



also see Time Selection	48-49	also see Auto-Bypass	28	User Program Code	51, 53, 54, 55
Test-Timer Offset Time	48	Day Zone	33	Watch Mode (Function 2)	59
Test-Timer Report Interval	48	Priority Arming	57	Watch On With Function 2	33
Testing the System	11	System Trouble		Wiring	8
also see Fault Find (Function 6)	60	Trouble On Open	50	Wiring Diagram	67
Locate (Function 5)	60	Trouble On Night Open	50	Wiring Legend	66
Time-Out	48	Trouble On Short	50	Wiring to a Grade-A Bell,	
also see Time Selection	48-49	Two-Digit Event Code Format,		see Alarm Outputs	27
Time Selection	48-49	see Data Format	32	Zone Descriptions, Programming	55-56
TouchTone Dialing Only	50	UL-Listed Devices, Compatible	5	Zones Bypassed (Display)	59
TouchTone With Rotary Backup	50	UL Mercantile Installation	11	24-Hour Protection	51
Trouble	50	User Keypad Programming	53	also see Abort Delay	25

INSTRUCTIONS: Should removal of the circuit board be necessary, use this wiring legend to relocate leads to their proper terminals. Enter wire identification number or color code in WIRE NUMBER column; enter wire function in DESCRIPTION column (optional).

TERMINAL NUMBER	WIRE NUMBER	DESCRIPTION
1		
2		
3		
4		
5		
6		
7		
8		
9		
10		
11		
12		
13		
14		
15		
16		
17		
18		
19		
20		
21		
22		
23		
24		
25		
26		
27		
28		
29		
30		
31		
32		
33		
34		
35		
36		
37		
38		
39		
40		
41		
42		
43		
44		
45		
46		
47		
48		

## MAGNUM ALERT 2000 SERIES

### WIRING DIAGRAM

(REFER TO OPERATION AND INSTALLATION INSTRUCTIONS WI411).

This equipment should be installed in accordance with the National Fire Protection Association's Standard 74 (National Fire Protection Association, Batterymarch Park, Quincy, MA 02269) and local codes. Information describing proper installation, operation, testing, maintenance, evacuation planning, and repair service is to be provided with this equipment. UL Listed Limited Energy Code is required. (3)

NAPCO SECURITY SYSTEMS, INC  
AMITYVILLE, N.Y. 11701

**IMPORTANT**  
For continued protection against fire, replace only with fuses of same type and rating. Shorting fuses to alter the case or to each other may cause damage to the circuit board. Always use fuse pullers.

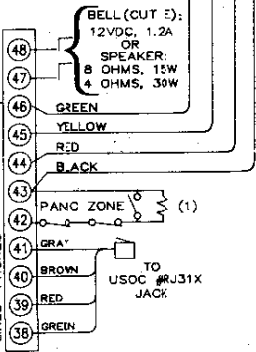
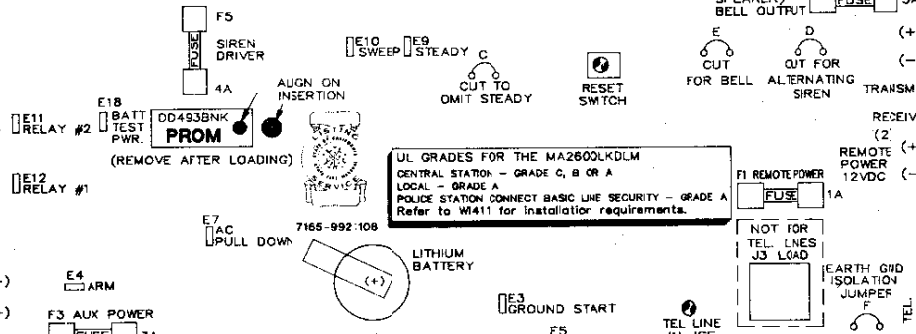
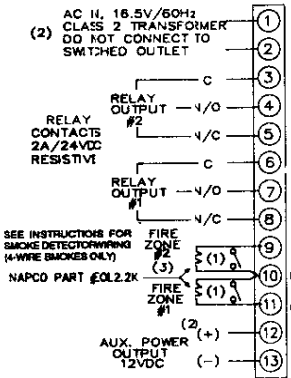
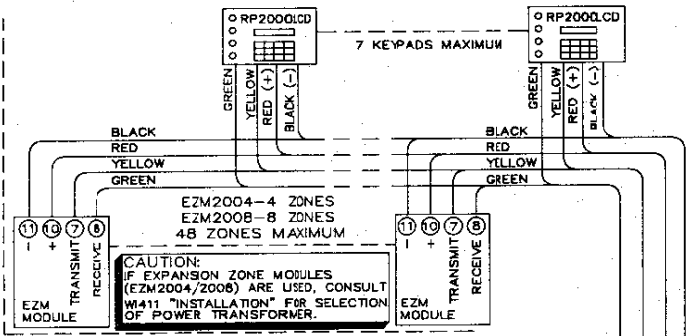

**COLD WATER GROUND CONNECTION**  
USE ONLY COLD-WATER PIPE OF BURIED GROUND ROD  
USE AT LEAST #14 AWG WIRE

**WARNING:**  
TO PREVENT RISK OF ELECTRIC SHOCK, DISCONNECT TELEPHONE LINES PRIOR TO SERVICING.

(2)  
- BLACK  
- RECHARGEABLE SEALED LEAD-ACID BATTERY  
- RED 12VDC  
REPLACE BATTERY EVERY 5 YEARS

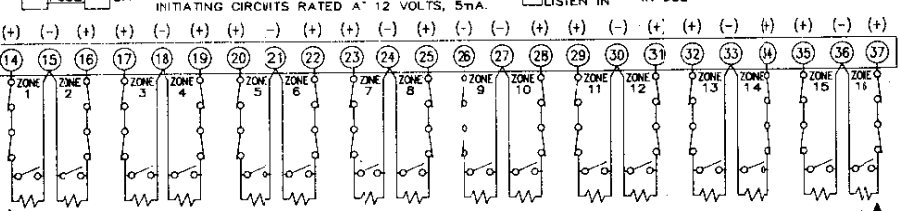

- (1) END-OF-LINE RESISTORS, 2200 OHMS, RED, RED, RID, 5/8 1/2W. ALSO INSTALLED IF ZONE IS NOT USED (INCLUDING FIRE AND PANIC). DO NOT INSTALL EOL RESISTOR ON FIRE ZONE IF USING FT2200 EOL RELAY.
- (2) COMBINED STANDBY CURRENT (AUX. POWER + REMOTE POWER): 350mA with TRF12 TRANSFORMER AND RBAT4 650mA with TRF11 TRANSFORMER AND RBAT6
- (3) REFERENCE TO FIRE ZONE FOR RESIDENTIAL APPLICATIONS ONLY AND SUBJECT TO LOCAL CODES. (MAY NOT BE USED FOR MERCANTILE INSTALLATIONS).
- (4) SYSTEM MUST BE TESTED AT LEAST ONCE A WEEK IN THE AC/BATTERY MODE AND IN THE BATTERY-ONLY MODE. (CONTACT: CENTRAL STATION PRIOR TO TESTING.) AC MUST BE RESTORED AFTER TEST.

## NAPCO LIMITED WARRANTY

**N**APCO SECURITY SYSTEMS, INC. (NAPCO) warrants its products to be free from manufacturing defects in materials and workmanship for fifteen months following the date of manufacture. NAPCO will, within said period, at its option, repair or replace any product failing to operate correctly without charge to the original purchaser or user.

This warranty shall not apply to any equipment, or any part thereof, which has been repaired by others, improperly installed, improperly used, abused, altered, damaged, subjected to acts of God, or on which any serial numbers have been altered, defaced or removed. Seller will not be responsible for any dismantling or reinstallation charges.

In case of defect, contact the security professional who installed and maintains your security system. NAPCO shall have no obligation under this warranty, or otherwise, if the product has been repaired by others, improperly installed, improperly used, abused, altered, damaged, subjected to accident, nuisance, flood, fire or acts of God, or on which any serial numbers have been altered, defaced or removed. NAPCO will not be responsible for any dismantling, reassembly or reinstallation charges.

In order to exercise the warranty, the product must be returned by the user or purchaser, shipping costs prepaid and insured to NAPCO. After repair or replacement, NAPCO assumes the cost of returning products under warranty.

*There are no warranties, express or implied, which extend beyond the description on the face hereof. There is no express or implied warranty of merchantability or a warranty of fitness for a particular purpose. Additionally, this warranty is in lieu of all other obligations or liabilities on the part of NAPCO.*

Any action for breach of warranty, including but not limited to any implied warranty of merchantability, must be brought within the six months following the end of the warranty period. In no case shall NAPCO be liable to anyone for any consequential or incidental damages for breach of this or any other warranty, express or implied, even if the loss or damage is caused by the seller's own negligence or fault.

*This warranty contains the entire warranty. It is the sole warranty and any prior agreements or representations, whether oral or written, are either merged herein or are expressly cancelled. NAPCO neither assumes, nor authorizes any other person purporting to act on its behalf to modify, to change, or to assume for it, any other warranty or liability concerning its products.*

In no event shall NAPCO be liable for an amount in

excess of NAPCO's original selling price of the product, for any loss or damage, whether direct, indirect, incidental, consequential, or otherwise arising out of any failure of the product. Seller's warranty, as hereinabove set forth, shall not be enlarged, diminished or affected by and no obligation or liability shall arise or grow out of Seller's rendering of technical advice or service in connection with Buyer's order of the goods furnished hereunder.

**NAPCO RECOMMENDS THAT THE ENTIRE SYSTEM BE COMPLETELY TESTED WEEKLY.**

**Warning:** Despite frequent testing, and due to, but not limited to, any or all of the following; criminal tampering, electrical or communications disruption, it is possible for the system to fail to perform as expected. NAPCO does not represent that the product/system may not be compromised or circumvented; or that the product or system will prevent any personal injury or property loss by burglary, robbery, fire or otherwise; nor that the product or system will in all cases provide adequate warning or protection. A properly installed and maintained alarm may only reduce risk of burglary, robbery, fire or otherwise but it is not insurance or a guarantee that these events will not occur. **CONSEQUENTLY, SELLER SHALL HAVE NO LIABILITY FOR ANY PERSONAL INJURY, PROPERTY DAMAGE, OR OTHER LOSS BASED ON A CLAIM THE PRODUCT FAILED TO GIVE WARNING.** Therefore, the installer should in turn advise the consumer to take any and all precautions for his or her safety including, but not limited to, fleeing the premises and calling police or fire department, in order to mitigate the possibilities of harm and/or damage.

NAPCO is not an insurer of either the property or safety of the user's family or employees, and limits its liability for any loss or damage including incidental or consequential damages to NAPCO's original selling price of the product regardless of the cause of such loss or damage. If the user wishes to protect itself to a greater extent, NAPCO will, at user's sole cost and expense, obtain an insurance policy to protect the user, supplemental to user's own policy, at a premium to be determined by NAPCO's insurer upon written notice from user by Certified Mail, Return Receipt Requested, to NAPCO's home office address, and upon payment of the annual premium cost by user.

Some states do not allow limitations on how long an implied Warranty lasts or do not allow the exclusion or limitation of incidental or consequential damages, or differentiate in their treatment of limitations of liability for ordinary or gross negligence, so the above limitations or exclusions may not apply to you. This Warranty gives you specific legal rights and you may also have other rights which vary from state to state.